



OWNER'S MANUAL

GUIDEBOOK TO ENJOYMENT OF
YOUR VENTURE RV
RECREATIONAL VEHICLE

***Sport Trek &
Sport Trek Toy Hauler***

THE PURPOSE OF THE VENTURE RV OWNER'S MANUAL IS TO PROVIDE THE MOST CURRENT INFORMATION AVAILABLE CONCERNING VENTURE RV RECREATIONAL VEHICLES. OPERATION AND MINOR MAINTENANCE IS THE MAIN FOCUS OF THIS BOOK.

CRITICAL SAFETY WARNINGS ARE INCLUDED AND **MUST BE READ AND OBEYED**

MAINTENANCE OF YOUR RECREATIONAL VEHICLE IS IMPORTANT TO KEEPING YOUR COACH IN GOOD CONDITION. FAILING TO PROVIDE MAINTENANCE, AS SUGGESTED, COULD RESULT IN LOSS OF WARRANTY COVERAGE. REVIEW THE COPY OF YOUR VENTURE RV TOWABLE TRANSFERABLE LIMITED WARRANTY, WHICH HAS BEEN SUPPLIED TO YOU WITH YOUR WARRANTY REGISTRATION FORM.

ADDITIONAL MANUALS MAY BE SUPPLIED AND AVAILABLE BY THE MANUFACTURER OF THE COMPONENT AND/OR APPLIANCE. SEE THE



Conventional Travel Trailer

We congratulate you on your purchase of a VENTURE RV, recreational vehicle. You have chosen a quality built RV which should provide you with many years of camping memories and fun.

The recreational vehicle you have purchased has been inspected by our trained inspectors and fully meets our high quality standards.

As the owner of a new VENTURE RV, you can rest assured that we will do all we can to keep you a "happy camper". Naturally, your selling dealership is always happy to help you with any questions you may have or service you may need. And should you need assistance when traveling, with VENTURE RV dealers nationwide, assistance is usually just minutes away.



VENTURE RV

0985 N 900 W
Shipshewana, IN 46565

TABLE OF CONTENTS

Chapter 1 – Introduction to RV Ownership	1
Safety Considerations	2
Reporting Safety Defects.....	2
Safety When Emergency Stopping.....	3
Additional Safety Considerations.....	3
Extended or Cold Weather Use	4
Condensation	4
Causes.....	4
Solutions.....	5
Interior Ventilation.....	6
Chapter 2 – Service Procedures	7
Basic Service Procedures	7
Dealer.....	8
Factory.....	8
Parts.....	8
Owner’s Responsibility	8
Seasonal Site.....	9
Towable Limited Warranty.....	10
Chapter 3 – Using Your RV	14
Equipment.....	14
Tow Vehicle	14
Hitches – Travel Trailer.....	14
Hitch Height Specifications – Travel Trailer.....	15
Hook-Up (Travel Trailer)	15
The Safety Chain (Travel Trailer)	16
Traveling.....	17
Weights	17
Weighing Vehicle (Loaded or Unloaded).....	18
Loading the Trailer—Distribution	18
Toy Hauler—Cargo Information	20
Interior, Cargo Area.....	21
Rear Cargo Door.....	22
Fuel Cell.....	22
Towing.....	24
Tires.....	24
Safety First-Basic Tire Maintenance	25
Understanding Tire Pressure and Load Limits.....	26
Tire Size	26
Tire Tread.....	27
Tire Balance and Wheel Alignment.....	27
Tire Repair.....	27
Tire Fundamentals.....	27

Vehicle Load Limits	28
Cargo Capacities	28
How Overloading Affects Your RV and Tires	29
Tire Speed Rating.....	29
Tire Safety Tips.....	29
Preventing Tire Damage	29
Tire Safety Checklist	30
How to Change a Tire.....	30
Wheel Bearings	31
Lugs.....	31
Brakes—Electrical	31
Breakaway Switch	32
Fire Extinguisher.....	33
Setting Up and Using Your Recreational Vehicle	33
Travel Trailer Hook Up.....	34
Safety Detectors.....	35
Propane/ Carbon Monoxide Detector.....	35
What is Carbon Monoxide?.....	35
Dual Sensor Technology.....	35
Operation.....	36
Lower Power Option.....	36
Visual and Audible Alarm Signals.....	36
CO Alarm.....	37
Propane Gas Alarm.....	37
Smoke Alarm.....	38
Operation.....	38
Testing.....	38
TV Antenna (Standard Roof Mount).....	39
To Test System.....	40
Steps-Two or Three	40
Windows.....	40
Doors.....	41
Slide Outs	41
Power For Operation.....	41
Trailer Set-Up Requirements-General.....	42
Below Floor Slide System.....	43
Above Floor Slide Out	43
Electrical Components.....	43
Manual Override.....	44
Below Floor Slide Out.....	44
Above Floor Slide Out.....	44
Blinds.....	44
Ladder-Outside.....	45
Chapter 4 – Systems.....	46
Water and Drainage Plumbing	46

Fresh Water System.....	46
Tanks.....	46
Filling Fresh Water System.....	46
12-Volt Demand Pump	48
Faucets.....	48
Bath and Shower.....	49
Outside Shower (Optional).....	49
Fresh Water Lines.....	50
Lo-Point Drains.....	50
Sanitizing and Filling the Potable Water System.....	50
For Gravity Fill and Storage Tank.....	51
For Direct Fill-City Water.....	51
Drainage (Fresh Water)	52
To Drain System.....	52
Sanitation System	52
Toilets.....	52
Using Toilet and Tank System.....	53
Vents.....	54
Holding Tanks.....	54
Draining the Tanks.....	55
Black Tank Flush System.....	55
Maintenance for Holding Tanks.....	56
Heated Fresh Water Tank.....	56
Winterizing Your Recreational Vehicle	56
By Pass Kit.....	58
Propane Fuel System.....	59
Propane Container.....	59
Servicing and Filling Propane Containers	60
Installing Propane Containers	61
Regulator.....	63
High Pressure Hoses with Acme Connectors.....	64
Main Supply Hose – Low Pressure	65
Operation.....	65
Checking for Leaks	66
Propane Consumption	67
Electrical System.....	69
General Information.....	69
Changes and Modifications.....	69
120 Volt AC System.....	69
Power Cord 30 Amp	69
Circuit Breakers and Box	70
GFCI Protection.....	71
12 Volt DC System.....	72
Converter.....	72
Auxiliary Battery	73

Circuit Breakers and Fuses-12Volt DC	74
Exterior Lights and Connector, 12V	75
Porch Lights.....	76
Brake Wiring.....	76
Chapter 5 – Appliances.....	77
Safety.....	77
Furnace.....	78
Thermostat.....	78
Operating Instructions.....	79
To Turn Off Appliance.....	79
External Vents.....	79
Ducting.....	80
Range and Oven Top Burner Operation	80
Operating Instructions.....	80
Top Burner.....	80
Oven Burner	82
Water Heater.....	83
DSI Models.....	83
Operating Instructions: Gas	83
Operating Instructions: DSI.....	83
Operating Instructions: Electric.....	85
To Turn Off Water Heater.....	85
Winterizing Your Water Heater.....	85
Refrigerator.....	86
Leveling.....	86
Operation During Travel.....	87
Venting.....	87
Moisture Reduction Heater.....	87
Door Sealing.....	87
Door Handles.....	88
Refrigeration Storage.....	88
Operating the Refrigerator Controls.....	89
Monitor Panel.....	90
Outside Kitchen (optional)	91
Fire Place (Optional).....	91

CHAPTER 1 INTRODUCTION TO RV OWNERSHIP

Welcome to the growing family of new VENTURE RV owners and the world of recreational vehicle travel. The purchase of your VENTURE RV product allows you to enter this type of camping and leisure travel. Your coach has been designed and engineered to offer many comforts of home. VENTURE Recreational Vehicles are designed and constructed to be used as temporary living quarters for camping and travel uses. The coaches are not intended for hauling cargo.

This owner's manual was prepared to assist you in understanding the proper use and operation of various containment systems, servicing and maintenance of component parts, and explanation of your warranty protection. If this is your first RV travel coach, you will want to acquaint yourself with all aspects and information found in this manual plus manuals supplied by component manufacturers.

These materials will reflect the most current information available for the user. Some components and items may not be in your coach as they may be options on different models.

Keep this owner's manual in your recreational vehicle for handy reference. Get to know your new vehicle and how it operates. You should carefully read and understand these instructions, as well as information supplied by the manufacturers of separately warranted products, since they contain important operating, safety, and maintenance instructions. If you have questions that are not adequately answered by this manual or other booklets, consult your dealer. If he cannot satisfactorily answer your questions, he will call our staff for additional information.

Every effort has been made to provide you with a safe, dependable product. Your vehicle complies with applicable requirements of Federal Motor Vehicle Safety Standards, State Regulations, Canadian Standards Associations (CSA) where applicable, and complies with requirements of ANSI Standard 1192, the nationally recognized "Standard for Recreational Vehicles – Installation of Plumbing, Heating and Electrical Systems." The Recreational Vehicle Industry Association (RVIA) and Canadian Standards Association (CSA) periodically inspect our production lines and assist us in maintaining strict compliance with installation and safety standards for those systems. **Your follow-up with periodic safety inspections and a program of preventive maintenance is important for the continuation of safe and trouble-free operation.**

Camping is a great way to relax and enjoy the outdoors with your friends and family. Please remember to tread lightly on our beautiful land and leave only your footprints so that others may enjoy nature as much as you did.

SAFETY CONSIDERATIONS

The terms **NOTE**, **CAUTION**, **WARNING** and **DANGER** have specific meanings in this manual as well as component manuals.

A **NOTE** provides additional information to make a step or procedure easier or clearer. Disregarding a **NOTE** could cause inconvenience, but would not be likely to cause damage or personal injury.

A **CAUTION** emphasizes areas where equipment damage could result. Disregarding a **CAUTION** could cause permanent mechanical damage. However, personal injury is unlikely.

A **WARNING** is giving notice to user that potential injuries may occur to a person from equipment and mechanical failure. Disregarding a warning may result in serious physical injury to occupant.

A **DANGER** alerts areas where safety measures **MUST BE STRICTLY ADHERED TO**, as such failure can be dangerous, causing serious injury and possible loss of life.

REPORTING SAFETY DEFECTS

If you believe that your vehicle has a defect which could cause a crash or could cause injury or death, you should immediately inform the National Highway Traffic Safety Administration (NHTSA) in addition to notifying VENTURE RV.

If NHTSA in addition receives similar complaints, it may open an investigation, and if it finds that a safety defect exists in a group of vehicles, it may order a recall and remedy campaign. However, NHTSA cannot become involved in individual problems between you, your dealer or VENTURE RV.

To contact NHTSA, you may either call the Auto Safety Hotline toll-free at 1-800-424-9393 or write to:

NHTSA
US Department of Transportation
Washington, DC 20590

You can also obtain other information about motor vehicle safety from the Hotline.

Safety When Emergency Stopping

It is wise to carry road flags and/or triangular warning devices to be used when necessary. When pulling off a highway, use your four way hazard lights as warning flashers, even if only to change drivers. Pull off the road way completely if at all possible to change flat tires or any other emergency needs.

Additional Safety Considerations

1. Sanitize the fresh water supply system periodically (see sanitizing instructions).
2. Keep water connection fittings from coming in contact with the ground or drain hose to reduce chance of contamination.
3. Enlist services of a Qualified RV Technician to fix gas or electrical appliances, or any other gas or electrical system problem.
4. Always have a serviceable fire extinguisher placed in an easily accessible location.
5. Insure that tires are in good condition and properly inflated. Watch tire inflation closely. Under-inflated tires will overheat. Overheated tires are a potential hazard as they may throw rubber and cause a blow-out. Check the tire pressure before each trip while the tires are cold.
6. Check and tighten the wheel lugs regularly (every 50 miles when new until 200 miles are reached and then check the lugs every 500 miles).
7. Check the brakes in a safe area – not while traveling on a busy highway.
8. Always block the trailer wheels solidly before unhitching.
9. Before leaving a camp area with a trailer in tow, insure:
 - a. The safety pin or locking lever is seated.
 - b. The breakaway wire is attached to the tow vehicle.
 - c. All jacks are raised so that they cannot touch the ground.
 - d. The 110 volt A.C. electrical cord is properly stored.

- e. The safety chains are connected.
 - f. All interior lights are off.
10. Observe and obey the warning labels attached to your vehicle concerning propane, water, electricity and loading.
 11. Extinguish all campfires before leaving your campsite.

EXTENDED OR COLD WEATHER USE

Your VENTURE recreational vehicle has been built for enjoyment in a recreational manner. This recreational vehicle is not intended to be used as full-time living quarters. Nor is this a four season unit. Using this unit in freezing conditions is not recommended. However, if unit is used in freezing weather, following are guidelines to follow. Any problems resulting from freezing are not covered under warranty.

1. For winter use in freezing conditions, more protection may be required. Use skirting and/or insulation below floor level to provide additional protection.
2. Remember, water freezes at 32° Fahrenheit whether fresh or drainage. Proper care must be used to protect any system at 32° Fahrenheit or lower. Local recreational vehicle dealers and campground personnel may be able to advise you on needed protection.
3. Energy requirements, such as propane and electrical supplies must be adequate. Protect your propane regulator from freeze-ups.
4. During cold weather you will experience more condensation than normal. Using ventilation or a dehumidifier may be needed.

CONDENSATION

Where it comes from, what causes it, and various solutions. Condensation is not a warranty issue.

Causes:

- A. When cooking food or taking a shower, warm moist air circulates throughout the coach attaching itself to cooler surfaces, forming beads and running down wall or window
- B. Normal breathing will emit approximately 1/2 pint of moisture into the air per person, per day. The more occupants the greater quantity of condensation you may find.

Solutions:

1. When taking a shower, open bath roof vent approximately ½ inch allowing moisture to escape.
2. Use the power vent over range when cooking.
3. If condensation is found in cabinet or closets, open door slightly to equalize temperature and provide ventilation.
4. Opening windows and roof vents, when possible, allowing warm moist air to escape is the best way to reduce condensation.
5. Under extreme conditions, you may need to use a dehumidifier to remove moist air conditions.

Uncontrolled condensation can cause dampness, mildew, etc., inside your recreational vehicle. Be sure to make strong efforts to control condensation.



CAUTION

Continuous living in your recreational vehicle could cause accelerated wear to components above recreational use.

Numerous ways are provided to exchange air in coaches.

1. Open windows on non-rainy days, allowing air exchange between inside and outside.
2. Power hood vent above cooking stove will send heat and food smell outside.
3. Roof vent; numerous types;
 - a. Standard air flow using gravity flow method.
 - b. Power (12v or 110v) vents will move air faster.
 - c. Hi-volume power vents, operation in 12 volt power can exchange air in a coach in several minutes if windows are open accordingly. If there is a fan in the rear, open window (s) in front.

Different brands/models have different features, such as remote control, rain sensor, variable speed control switch, etc.

Read carefully the operating instructions which are provided by the manufacture and can be found in your coach.

CHAPTER 2 SERVICE PROCEDURES

BASIC SERVICE PROCEDURES

VENTURE RV and Your VENTURE RV Dealer have a strong and dedicated interest in maintaining the highest quality customer relations with its owners. Your satisfaction with your VENTURE recreational vehicle and your VENTURE RV dealer is our primary concern. In addition to producing high quality products, we want to assure our customers of our support with parts and service availability. **Our dealer network is the first choice to serve and supply your needs for your recreational vehicle.** Our authorized dealers will pleasantly assist in providing service maintenance needs plus parts, options, and information concerning your recreational vehicle.

Should you experience a problem with service availability, please follow the steps in the order listed below.

1. Contact your selling dealer's service department for an appointment. Describe to the best of your knowledge the nature of the problem. Please keep appointments to establish a good, workable relationship.
2. Contact the owner or general manager of the dealership should the initial attempt fail with the service department.
3. Contact:
Customer Relations Department
VENTURE RV
0985N 900W
Shipshewana, IN 46565

Phone: (888) 988 8440
Hours: (8am-5pm E.S.T.)

E-mail: venture@venture-rv.com
Website: <http://www.venture-rv.com>

Give all the above information as requested along with the serial number of the coach in question. We will make every attempt to resolve your problem.

Please bear in mind that most problems arise from misunderstandings concerning warranty coverage and service. In most instances, you will be referred to the dealer level and your concerns will be resolved with the dealer's facilities and personnel.

Dealer

Your authorized VENTURE RV dealer has performed a PDI (pre-delivery inspection) on your recreational vehicle. Since your dealer is authorized to sell VENTURE RV products, they are also there to supply parts, optional equipment, and provide service repairs, warranty or otherwise as needed.

First choice for warranty repairs is your selling VENTURE RV dealer. Other dealers can be used, however, prior approval is required.

Some recreational vehicle dealers may be authorized service centers for certain manufacturers of products warranted separately, such as appliances. Check with your dealer before contacting anyone else to reduce delays. If the dealer is not an authorized service center for the product in question, he can assist you in obtaining authorized service.

Factory

Service repairs can be performed at the manufacturing facility at Shipshewana, Indiana. Should your VENTURE RV product be in need of major repairs and your dealer recommends factory repairs, please follow the steps listed below for such work.

1. Your dealer **must** make an appointment with service personnel at the factory PRIOR to your arrival.
2. Any freight costs, are the responsibility of the owner as listed in the warranty coverage schedule.

Parts

Stocking of parts varies from dealer to dealer. Any authorized dealer can order any required part to be shipped to their dealership. All parts are obtained through authorized VENTURE RV dealers only.

Owner's Responsibility

When owning and using a recreational vehicle, it is important to perform regular and normal maintenance. This is recommended twice a year, spring and fall, to prevent undesired deterioration of your coach. Weather elements play an important function on sealants and other components requiring normal maintenance.

As an owner and operator, it is your responsibility and obligation to inspect and return your coach to an authorized dealer for repairs as required. Your authorized selling dealer is always your first choice and he certainly has continued interest in your satisfaction. As your manufacturer, we recommend that inspection and service be performed by your selling dealership.

If you are traveling and are unable to locate an authorized VENTURE RV dealer, or an authorized dealer for the component needing service, please call our customer service office at (888)988-8440. Service at a non-authorized dealer MUST have prior authorization. You may be asked to return any mechanical parts that are replaced before reimbursement consideration is made. Unauthorized or improper repairs may void the warranty of that component. Always keep your owner's manual along with a copy of your warranty registration with you when traveling.

Seasonal Site

When placing your unit on a camp site in the spring and returning it in the fall to your home, it's classed as a "seasonal site."

Performing repair work on such a site is not recommended for numerous reasons; available parts, tools, space, weather conditions, etc.

Any service repairs which require a service technician also require the unit to be taken to a service facility, preferably your selling dealer.

Warranty coverage does not include trip or service call costs for such a trip. It is the owners responsibility to provide for such costs.

KZRV, LP d/b/a VENTURE RV TOWABLE LIMITED WARRANTY

One Year Limited Warranty

SUMMARY OF WARRANTY: Venture RV warrants that every towable recreational vehicle or truck camper purchased from an authorized Venture RV dealer to the first retail consumer was free from substantial defects in materials and workmanship when it arrived on the dealer's lot, except those exclusions set forth below. Nothing contained herein shall be interpreted as a promise of future performance. The warranty period begins on the date of purchase or the date the unit is first placed in service, whichever is earlier. This Towable Limited Warranty ["TLW"] does not apply to towable recreational vehicles or truck campers purchased from any source other than an authorized Venture RV dealer.

EXCLUSIONS FROM WARRANTY: Excluded from coverage under the TLW are: (1) items added, changed, or modified after the unit left the possession of Venture RV; (2) units used for any commercial purpose; (3) units used for full-time residential use or more than occasional recreational use; (4) wear and tear caused by normal usage by the consumer, including but not limited to fading or discoloration of soft goods [e.g., tents, upholstery, drapes, carpet, vinyl, screens, cushions, and mattresses], fading or discoloration of exterior or fiberglass components, tears, punctures, soiling, mildew, mold, and the effects of moisture condensation inside the unit; (5) the effects of alteration, tampering, mishandling, neglect, abuse, misuse, weather, acts of nature, acts of God, or corrosive atmospheres that promote rusting, oxidation, or pitting; (6) minor imperfections that do not interfere or affect the suitability of the unit for its intended use; (7) the effects of consumer's or transferee's failure to perform normal and routine maintenance [e.g., inspections, lubrication, adjustments, tightening of screws and bolts, tightening of lug nuts and wheels, sealing, rotating, cleaning, or other damages resulting from failing to follow the maintenance schedule and procedures in the owners manual; (8) damages resulting from misalignment or adjustments to axles or spindles caused by improper maintenance, modification, loading, unloading, road hazards, road defects, off road travel, or tire failures; (9) damages caused by the negligent or intentional use or misuse of the unit by the consumer or transferee, including but not limited to occurrences while towing the unit; (10) loss or damage caused by a person or business as a result of transporting the unit after sale to the consumer, delivering the unit, or parking the unit; (11) loss or damage to the plumbing system caused by freezing; (12) claims for personal injuries of any type; (13) costs of transportation of the unit for repairs; and (14) components that are warranted separately by another manufacturer [the warranty provided by a component manufacturer is the sole responsibility of that manufacturer, and Venture RV does not warrant those components. Please refer to the warranties issued by the component manufacturers for the terms and conditions of such warranties].

TO OBTAIN WARRANTY SERVICE: Warranty service may be performed only at Venture RV, or at Venture RV authorized dealers and service centers. Contact Venture RV for a list of authorized dealers and service centers. **REPAIRS OR REPLACEMENTS BY UNAUTHORIZED DEALERS OR SERVICE CENTERS WILL VOID THIS TLW.** If the consumer believes that a claimed defect is covered by this TLW, contact must be made with VENTURE RV, as described below, or an authorized Venture RV dealer, **WITHIN THE WARRANTY PERIOD.** Sufficient information must be given to attempt to resolve the claimed problem. Should Venture RV determine that repair or replacement is appropriate, the consumer must deliver the unit to the dealer or service center as directed. Delivery shall occur no later than thirty (30) days after the authorization for repair or replacement. Do not deliver your unit to Venture RV, an authorized dealer, or service center without prior authorization. All costs incurred by the consumer for transportation for warranty service shall be the sole responsibility of the consumer. The consumer must contact Venture RV by **CERTIFIED MAIL** with a written description of the claimed warranted defect and the efforts to remedy it. **FAILURE TO SO NOTIFY Venture RV IN THIS REGARD SHALL RENDER THIS TLW VOID AS TO THE CLAIMED DEFECT.** The scheduling of warranty work at an authorized dealer or service center is not controlled by Venture RV and delays may be experienced. Venture RV is not responsible for loss of use of the unit, expenses for fuel, telephone, food, lodging, travel, loss of income or revenue, or loss of or damage to personal property.

DISCLAIMER AND LIMITATIONS OF WARRANTIES: NEITHER VENTURE RV, NOR ITS DEALERS SHALL BE LIABLE FOR INCIDENTAL, CONSEQUENTIAL, INDIRECT, SPECIAL, OR PUNITIVE DAMAGES OF ANY KIND OR ANY OTHER FINANCIAL LOSS ARISING OUT OF OR IN CONNECTION WITH THE SALE OR USE OF THIS PRODUCT, WHETHER BASED IN CONTRACT, TORT, STRICT LIABILITY, EQUITY, OR ANY OTHER THEORY, EVEN IF Venture RV HAS BEEN ADVISED OF THE POSSIBILITY OF SUCH DAMAGES. Venture RV'S ENTIRE LIABILITY SHALL BE LIMITED TO REPAIR OR REPLACEMENT, AT Venture RV'S SOLE OPTION. THE UNITED NATIONS CONVENTION ON CONTRACTS FOR THE INTERNATIONAL SALE OF GOODS IS HEREBY EXCLUDED IN ITS ENTIRETY FROM APPLICATION TO THIS TLW. THIS TLW, AND THE REMEDIES HEREUNDER, ARE EXCLUSIVE AND IN LIEU OF ALL OTHER WARRANTIES, EXPRESS OR IMPLIED, INCLUDING WARRANTIES OF MERCHANTABILITY, FITNESS FOR A PARTICULAR PURPOSE, CORRESPONDENCE WITH DESCRIPTION, AND NON-INFRINGEMENT, ALL OF WHICH ARE EXPRESSLY DISCLAIMED BY Venture RV. THIS TLW GIVES YOU SPECIFIC LEGAL RIGHTS AND YOU MAY ALSO HAVE OTHER RIGHTS THAT VARY DEPENDING ON LOCAL LAW. SOME STATES LIMIT OR PROHIBIT LIMITATIONS OF WARRANTIES, SO THE ABOVE MAY NOT APPLY TO YOU. YOU SHOULD CONSULT A COMPETENT ATTORNEY FOR LEGAL ADVICE

MISCELLANEOUS: No repair or replacement effected shall cause any extension or renewal of the warranty period. Venture RV may make parts and/or design changes from time to time without notice and repairs or replacements may be made with new or different parts. Venture RV reserves the right to make changes in the design or material of its products without incurring any obligation to incorporate such changes in any product previously manufactured. At Venture RV's, sole option, any dispute concerning any warranted defect may be resolved through mediation or arbitration. This TLW shall be governed by the laws of the State of Indiana, and any legal action shall be brought only in the Circuit or Superior Court of LaGrange County, Indiana. In case of conflicts between this TLW and any other warranties issued or conveyed by Venture RV, the terms of this TLW shall govern.

ALTERNATIVE DISPUTE RESOLUTION: The parties shall attempt in good faith to resolve any disputes by negotiations. If unsuccessful, Venture RV may, in its sole discretion, elect to submit the matter to binding arbitration and, if such election is exercised, the consumer covenants and agrees that he, she, they, or it shall submit any such disputes to such binding arbitration. The arbitral body shall be either the American Arbitration Association or the National Arbitration Foundation, and the rules of the body chosen by Venture RV shall govern except to the extent same are in conflict with the Indiana Uniform Arbitration Act, which shall govern. The arbitrator is expressly empowered to enter an award of default against any party in the event of: (a) the failure or refusal of such party to comply with any deadline fixed by the arbitrator; (b) the failure or refusal of such party to make timely payment of any fees, expenses, or other charges billed by the arbitrator; or (c) any other failure or refusal by such party to cooperate and participate in any aspect of the arbitration proceedings. The arbitrator will admit only relevant and reliable evidence at the hearing, but no particular rules of evidence are specified for use. The hearing shall be electronically recorded by an Indiana Notary Public or other officer authorized by Indiana law to administer oaths, and all witnesses who shall testify shall be sworn on oath to tell the truth. The arbitrator may award injunctive relief, interest, and attorney fees in an equitable amount based upon the degree to which the prevailing party prevails on the merits; however, the arbitrator is not empowered to award punitive or exemplary damages. All costs of the arbitration, including the recording thereof, shall be shared equally by the parties. The arbitration proceedings and award shall remain confidential, and no party may disclose to any person, except attorneys for the parties, any aspect of the proceedings.

WARRANTY REGISTRATION AND CONTACT INFORMATION:

The warranty registrations for component parts should be completed and delivered in accordance with the instructions contained therein. The TLW registration must be completed and returned to Venture RV within fifteen (15) days of delivery of the unit to the consumer. Failure to do so can void this TLW or cause delays in obtaining benefits. The TLW registration, and all inquiries, must be directed to: VENTURE RV, Warranty Department, 0985N 900W, Shipshewana, Indiana 46565, Telephone: (260) 768-4016. [Form 1 year 6-1-12]

Model Number _____ *V.I.N.* _____

Dealer Information:

[_____]

Customer Information:

Name: _____

Address: _____

Phone: _____

I HEREBY ACKNOWLEDGE THAT I HAVE RECEIVED, READ, AND UNDERSTAND THIS TOWABLE LIMITED WARRANTY, AND THAT I HAVE INSPECTED THE UNIT AND FIND IT IN THE CONDITION REPRESENTED.

Date: _____

Purchaser

CHAPTER 3 USING YOUR RV

In this chapter you will find three areas of useful information to assist you with correct **equipment**, **traveling**, and finally, actually **using your recreational vehicle**.

EQUIPMENT

Tow Vehicle

Begin your camping experiences by obtaining a tow vehicle which will adequately transport your recreational vehicle to and from your chosen destinations. Your most important measuring tool is the GVWR, Gross Vehicle Weight Rating, to cross match the capability of your selected tow vehicle.

Most auto and truck provide trailer towing guides for their products, as do most auto or truck manufacturers. Ask your local automotive dealer for a copy or call the factory's direct lines for information. Many tow vehicles, including mini-vans, have special towing package options available for small travel trailers. Tow vehicles with long wheel bases perform better than those with short wheel bases.

A second factor is GCWR, Gross Combined Weight Rating, which refers to the total weight of the tow vehicle and any vehicle in tow as a "combined" weight. This information, supplied by the tow vehicle manufacturer, is related to the capability of the tow vehicle.

The condition of the suspension in your tow vehicle is also an important factor. Make sure your tow vehicle is in good operating condition and follow the factory recommended maintenance guidelines.

Hitches – Travel Trailer

After obtaining your tow vehicle, it is very important to choose, and have installed, a correct hitch system with weight distributing bars to accommodate your coach if so required. This selection and installation should be done by a professional hitch service center, which may or may not be your selling dealer. Sway controls may be needed based on size and weight of coach, plus capability of your Tow Vehicle.

Weight distributing hitches apply leverage between the tow vehicle and trailer. This assists in equalizing the weight between vehicles, resulting in both vehicles traveling level. The condition of the tow vehicle's suspension system will affect the towing performance capability of your equipment.

 **CAUTION**

Trailers with tandem axles need to travel as level as possible, avoiding different weights on each axle plus handling conditions.

 **CAUTION**

Using an oversized or undersized hitch can cause damage to the frame of your travel trailer or tow vehicle.

Hitch Height Specifications – Travel Trailer

Due to axles being either straight or drop bars, the ball height will vary. To find the correct height for the ball hitch, set your trailer on a flat surface in level position. Measure from the inside of the ball socket to the ground, approximately 18 to 22 inches as shown, for correct spacing. You may wish to add 1 to 2 inches to this amount to compensate for sag of suspension of the tow vehicles when hooked up to travel trailer.

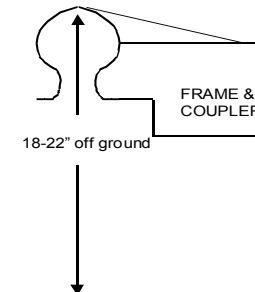

Hook-Up (Travel Trailer)

Hooking up your travel trailer is not difficult and gets easier with practice. The following procedure will help you until you become more experienced.

1. To raise the tongue of trailer above the hitch ball on hitch, turn the crank on the jack.
2. Open the coupler latch.

3. Back the tow vehicle into proper position.
4. Turn the crank on the jack to lower the coupler onto the ball hitch.
5. Close the coupler latch after completely seated.
6. Install weight distributing bars (equalizer), when required, as recommended by hitch supplier.
7. Retract the tongue jack to its maximum height.
8. Attach the cable for the breakaway switch to the tow vehicle.
9. Attach safety chains as per your state laws.
10. Attach in your 12-volt, seven way electrical connector from the tow vehicle to the trailer connector.
11. Below are listed numerous items that should be inspected and tested before traveling:
 - All lights working on outside of coach.
 - Stabilizer jacks in retracted position.
 - Steps in retracted position.
 - Refrigerator door latched completely.
 - Loose items in secure position.
 - Test brakes for operation before entering roadway.

The Safety Chain (Travel Trailer)

Safety chain requirements will vary from state to state. The chain supplied with your coach meets SAE requirements for maximum gross trailer weight.

1. Cross the left chain under the coupler and attach to the right ring on hitch receiver of tow vehicle
2. Now take right chain under the coupler and attach to left ring on hitch receiver.



CAUTION

Remember – always have the safety chain attached to tow vehicle, as required in your state.

TRAVELING

Weights

For safety reasons and federal regulations VENTURE RV provides accurate weight specifications to owners. On the exterior left front corner of the coach you will find the Federal "Vehicle Identification Number" sticker, as required by the federal government. This tag supplies information concerning your coach, such as: VIN number, date/month of manufacture, tire size rating, plus information about weights as described below.

Gross Axle Weight Rating (GAWR): is the value specified as the load carrying capacity of a single axle system, as measured at the tire-ground interfaces. One of five components will determine this rating: tires, axle, springs, brakes, or wheels. One of these five is generally rated slightly less than the others, which is used for the rating.

Gross Vehicle Weight Rating (GVWR): is the maximum permissible weight of this trailer when fully loaded. It includes all weight at the trailer axle(s) and tongue. This includes ALL cargo, options and liquids.

Unloaded Vehicle Weight (UVW): is the weight of this trailer as manufactured at the factory. It includes all weight at the trailer axle (s) and tongue. If applicable, it also includes full generator fluids, including fuel, engine oil and coolants.

Cargo Carrying Capacity (CCC): is equal to the GVWR minus each of the following: UVW, full fresh (potable) water weight (including water heater, and full propane weight.

MANUFACTURED/FABRIQUE KZRV L.P. DATE
GVWR/PNBV; SHIPSHEWANA,I IN.
GAWR/PNBE;
WHEEL/JANTE;
COLD INFL.PRESS/PRESS DE GCNFL.A. FROID
THIS VEHICLE CONFORMS TO ALL APPLICABLE U.S. FEDERAL
MOTOR VEHICLE SAFETY STANRDARDS IN EFFECT ON THE
DATE OF MANAFCTUER SHOWN ABOVE.

VIN/NIV NUMBER

Weighing Vehicle (Loaded or Unloaded)

The proper method to weigh the coach is to use a truck scale. Place the coach axles (tires) and tongue jack, 12" to 24" from the edge. Unhook the tow vehicle and move forward 6" to 8". Now record total weight. Re-hook the tow vehicle. Be sure no part of tow vehicle is on the scale. Now record the axle weight only. The difference between the two weights is the hitch weight.

VENTURE RV suggests you also weigh each side (2 tires) separate to find balance of pounds per side. Its possible to have 1 side correct and the other side over-loaded. Often the slide out side or refrigerator side will be slightly heavier than the other.

The **second sticker** is about the weight of cargo placed in your coach. Location is on the inside of your coach, on the screen door, or inside of a cabinet door. It provides listed total allowable weight of cargo minus liquids allowed, water and propane.

RECREATIONAL VEHICLE TRAILER CARGO

VIN. _____

The weight of cargo should never exceed

Kg. _____ **Lbs.** _____

A full load of water equals _____kg. Or _____lbs of cargo @ kg. or 8.3 lbs. per gallon.

Loading the Trailer—Distribution

Your recreational vehicle has been engineered to make maximum use of the available space for living and storage areas. The equipment and supplies you take along while traveling can be carried safely, provided the additional weight is distributed properly. Proper weight distribution within your trailer is an important factor in safety and efficiency of your trailer brakes, hitching, and how your tow vehicle will pull the trailer. DO NOT put excess weight in the rear only. Excessive weight in the rear area tends to develop sway and "fishtailing" of the trailer.

Lightweight and bulky items such as paper products, bedding, clothing, etc., should be stored in overhead cabinets and closets. Heavy items such as cooking utensils should be placed in lower cabinets. Canned goods need to be in a pantry, if so equipped, or in lower cabinets. Also, heavy items should be secured to avoid shifting during travel.

A reasonable principle in loading your coach is for every two pounds of weight loaded in front of the axle, one pound of weight must be loaded behind the axle. Also remember, improper side-to-side loading affects leaf spring condition.



CAUTION

DO NOT overload your unit. Please follow the GVWR when loading your Venture recreational vehicle to avoid damages.



CAUTION

Any damage caused by improper loading or installing additional equipment is **NOT** covered by Venture RV Limited Warranty.



WARNING

The rear bumper on the frame will only carry 100lbs, therefore only the spare tire carrier, and spare tire can be added to the bumper. Do not add any other components to the bumper, such as bike racks, generators, cargo containers, and etc. Such items could cause fatigue and weld stress, which is not covered under warranty. Any such failures could damage your property and endanger vehicles following your camper during travel, which could result in an accident.

However there is an option available to carry bikes and accessories. This option is an " Flip up Cargo Tray " which will carry bikes and cargo/ accessories. This cargo tray supports are welded onto the frame rails and **MUST** be ordered with unit, before it's built. This option can not be added after unit is built.. Weight limit is 250 lbs. Do not exceed the stated weight limit.

Excess weight behind the axle lightens the hitch weight and will tend to magnify any sway that may occur when passing trucks or when gusty winds are present. Uncalculated weight can and will effect road performance.

When using a weight distributing hitch and equalizer bars, you may move/transfer hitch weight from coach to tow vehicle assisting with level towing and easier travel.

TOY HAULER—CARGO INFORMATION

In Toy Hauler units, you may place 40% of (C.C.C.) carrying cargo capacity in rear area, and then distribute remaining pounds. Place 2 pounds in front of axle to every 1 pound behind axle, some of this weight will be on top of axles.

Below is a blank space for you to calculate the “ Cargo Carry Capacity “ of your unit, based on this 40% formula. You will find the weights of your unit on a sticker, placed on the edge of the screen door. This will enable you to determine your “ Cargo Carry Capacity “ in the different areas of your unit.

When loading heavy cargo/contents into the rear storage area, you MUST have the stabilizer jack in down position for any vehicle movement, for support.

Since Toy Haulers are designed and built to carry cargo in the rear portion of the unit, special care must be exercised in loading to prevent potential handling concerns.

Any cargo in rear area, MUST BE secured behind axles, during movement of unit. For this reason, D Rings are installed on the floor of the cargo room.

Any two wheel items such as bicycles or motorcycles, will require additional support for the front wheel, such as a “ wheel chock “. Any such stabilizer item such as a wheel chock, should be installed per manufacture instructions.

The tie downs (D Rings) provided are for general purpose use, rating of 1,500 lbs., each.

Please refer to owners manuals or contact the manufacture of these specific items for more information.

 **DANGER**

Any motorized vehicle or any motorized equipment powered with flammable liquid can cause fire, explosion, or asphyxiation if stored or transported within the recreational vehicle. To reduce the risk of fire, explosion, or asphyxiation:

- 1. Passengers shall not ride in the vehicle storage area while vehicles are present.**
- 2. Occupants shall not sleep in the vehicle storage area while vehicles are present.**
- 3. Doors and windows in walls of separation (if installed) are to be closed while the vehicles are present.**
- 4. Fuel shall run out of engine of stored vehicles after shutting off fuel at the tank.**
- 5. Motor fuel shall not be stored or transported inside the vehicle.**
- 6. The vehicle storage area shall be ventilated.**
- 7. Propane appliances, pilot lights, or electrical shall not be operated when motorized vehicles or motorized equipment are inside vehicle.**

FAILURE TO COMPLY COULD REASULT IN AN INCREASED RICK OF FIRE, EXPLOSION OR ASPHYXIATION, DEATH OR SERIOUS INJURY.

Interior, Cargo Area

- * Cargo Area. When sleeping or occupying this area, care, must be taken. There are two vents, one located on each side. These vents must be open if the presence of gasoline filled equipment is in the cargo area.
- Sleeping commendations. Available option is a power lift bed. This bed assembly is attached to the sidewall at all four corners

of the bed. Bed assembly can be raised or lowered as needed through a 12 volt D.C. motor source. Switch is located on the sidewall. The power bed assembly can be raised to the ceiling allowing storage.



The available options: (1) One bed with 1 matt (2) Two beds with a matt on each. (3) Sit N Sleep is a set of dinette cushions attached to a special frame, mounted onto power bed. Center part will flip over and become back seat for a dinette. In bed position all four cushions form into a bed.

Weight rating and limit on the power bed is 600 pounds. Static (stationary) and 450 pounds dynamic (moving).

Rear Cargo Door

Rear door on Toy hauler is “ spring loaded “, also known as having preset and designed springs attached along with hinge assembly at the bottom of the door. As you lift up or down these springs support most of the weight. A latch on each side ensures tightness when closed. Handle will latch into lock when closed. Lock may be secured with key.

FUEL CELL (OPTION)

Fuel Cell The fuel cell system was developed for each owner to carry gasoline in a tank installed under the frame between two special cross members welded to the frame. The tank is attached with three cross bars bolted to the frame members with grade #5 bolts and nuts. Fuel in the single tank will supply gasoline for generator plus any toys having a gasoline motor. When dual tanks are installed, front tank feeds only generator and rear tank supplies fuel to be dispersed to a motorized vehicle. Each tank will have its own gauge giving fuel available in tank. Rear tank will have a pump, hose, and discharge nozzle.

Power for the pump is supplied by a 12 volt battery, or convertor when 120 AC power is available. It is fused through the 12 volt panel in the load center. Don't forget to connect ground jumper wire.

All required hoses, along with vents are installed. Place nozzle into tanks and squeeze handle to release fuel into desired container.

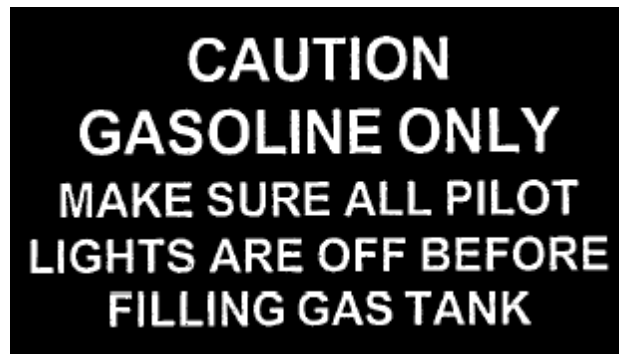

WARNING: The nozzle DOES NOT have a “ automatic shutoff” on it.



NO SMOKING, BEFORE DISPENSING FUEL, TURN OFF ALL ENGINES, FUEL-BURNING APPLIANCES, AND THEIR IGNITORS. CONNECT THE BONDING JUMPER WIRE TO THE VEHICLE RECEIVING FUEL. DO NOT DISPENSE FUEL WITHIN 20 FEET OF AN IGNITION SOURCE. FAILURE TO COMPLY COULD RESULT IN FIRE, DEATH, OR SERIOUS INJURY.

Towing

When towing your trailer you need to recognize the extra weight behind your vehicle. Below is a list of things you need to remember while traveling.

1. With the trailer attached you will have slower acceleration and will require more distance to stop.
2. Be sure you have enough area at corners when turning, as wider turns are necessary. Be sure to use your turn signals for your own safety and the safety of others.
3. In passing or changing lanes remember you will need a longer distance to pass.
4. Use your rear view mirrors frequently to observe your trailer and traffic conditions.
5. When being passed by a large truck or bus, be prepared for displaced air as it may cause you to sway slightly, especially travel trailers.
6. When climbing steep, long grades and again while descending, use lower gears even before it seems necessary. Use your brakes smoothly and evenly.
7. Remember to drive more slowly on wet and icy highways to keep control of your vehicle.

Tires

All VENTURE RV towable coaches are equipped with appropriate tires for recreational vehicles. Tires are rated to carry weight as listed to G.V.W.R. Tires are radial in design using components to offer excellent strength and mileage in all kinds of weather conditions.

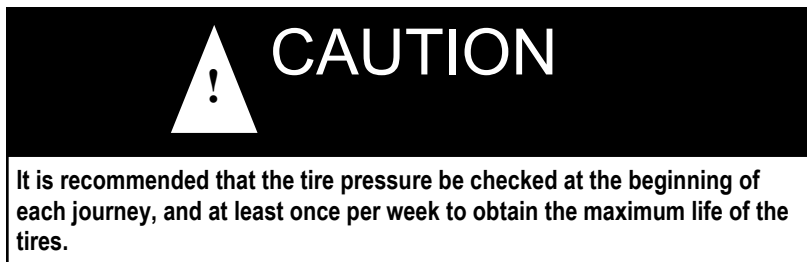

Tires on your vehicle(s) are one of the most important components of the towing package. Without inflated tires you will not be moving anywhere.

Taking care of your tires during travel is very important. Top of the list is maintaining correct air pressure and secondly is NOT over loading your R.V.

With proper care, the performance of fuel economy and handling on the road will be better.

Safety on the road is also very important in avoiding road hazards which can damage your tires plus obeying the speed limits.

On the left front, exterior corner of your coach, you will find the (VIN) label along with a placard supplying information on tires such as, size and the amount of air pressure to carry.

Both placard and certification labels are permanently attached to the trailer on left front corner of exterior and easily readable from the outside of the vehicle without removing any covers. Due to weather elements, labels may fade over time. You may wish to record this information and keep it on the inside of coach, perhaps with the owners manual.

TIRE PNEU	SIZE DIMENSIONS	COLD TIRE PRESSURE PRESSIONDES PNEUS A FROID
FRONT AVANT		
REAR ARRIERE		
SPARE DESECOURS		

Safety First-Basic Tire Maintenance

Properly maintained tires improve the steering, stopping, traction,

and load carrying capability of your vehicle. **Under inflated tires and overloaded vehicles are a major cause of tire failure.** As mentioned above, to avoid flat tires and other types of tire failure, you should maintain proper tire pressure,

Understanding Tire Pressure and Load Limits

Tire inflation pressure is the level of air in the tire that provides it with load-carrying capacity and affects the overall performance of the vehicle. The tire inflation pressure is a number that indicates the amount of air pressure—measured in pounds per square inch (psi) - a tire requires to be properly inflated. (You will also find this number on the vehicle information placard expressed in kilopascals (kPa), which is the metric measure used internationally.)

The listed amount of air pressure is for maximum load capacity. When traveling with less than full weight, you may wish to reduce air pressure slightly for smoother ride

While driving your tires will get warmer, causing air pressure to increase. To get an accurate pressure reading, you must allow tires to cool for three hours or more.

For convenience, purchase a pressure gauge to keep in your tow vehicle. Gauges can be purchased at auto parts stores.

Because tires are designed to be used on more than one type of vehicle, tire manufacturers list the “maximum permissible inflation pressure” on the tire sidewall. This number is the greatest amount of air pressure that should ever be put in the tire under normal driving conditions.

The recommended tire inflation pressure that vehicle manufacturers provide reflects the proper psi when a tire is cold. The term cold does not relate to the outside temperature. Rather, a cold tire is one that has not been driven on for at least three hours.

Tire Size

To maintain tire safety, purchase new tires that are the same size as the vehicle’s original tires or another size recommended by the manufacturer. Look at the tire information placards, or the sidewall of the tire you are replacing to find this information. If you have any doubt about the correct size to choose, consult with the tire dealer.

Tire Tread

The tire tread provides the gripping action and traction that prevent your vehicle from slipping or sliding, especially when the road is wet or icy. In general, tires are not safe and should be replaced when the tread is worn down to 1/16 of an inch. Tires have built-in tread wear indicators that let you know when it is time to replace your tires. These indicators are raised sections spaced intermittently in the bottom of the tread grooves. When they appear “even” with the outside of the tread, it is time to replace your tires. Another method for checking tread depth is to place a penny in the tread with Lincoln’s head upside down and facing you. If you can see the top of Lincoln’s head, you are ready for new tires.

Tire Balance and Wheel Alignment

Tires are not balanced on your unit, nor is it required. You may choose to balance the tires on your unit, however this will not be covered under warranty.

Wheel alignments may be needed periodically due to road hazards, such as pot holes, etc. This also is not covered under warranty, due to being a uncontrollable element. Wheel alignments, will assist with getting the maximum life from your tires. Alignments require special equipment, and should be performed by a qualified technician.

Tire Repair

The proper repair of a punctured tire requires a plug for the hole and a patch for the area inside the tire that surrounds the puncture hole. Punctures through the tread can be repaired if they are not too large, but punctures to the sidewall should not be repaired. Tires must be removed from the rim to be properly inspected before being plugged and patched.

Tire Fundamentals

Federal law requires tire manufacturers to place standardized information on the sidewall of all tires. This information identifies and describes the fundamental characteristics of the tire and also provides a tire identification number for safety standard certification and in case of a recall.

Considerable quantity of information is built in to the side wall of a tire, such as date of manufacture, size, weight limit tire can carry, air pressure, serial number, where it was built

The letters “ST” refer ‘s to “service trailer” used on most Recreational Vehicles, manufactured for that very purpose.

- **Maximum Load Rating**—This number indicates the maximum load in kilograms and pounds that can be carried by the tire.
- **Maximum Permissible Inflation Pressure**—This number is the greatest amount of air pressure that should ever be put in the tire under normal driving conditions.

Vehicle Load Limits

Determining the load limits of a vehicle includes more than understanding the load limits of the tires alone.

On a trailer, there is a Federal certification label that is located on the forward half of the left (road) side of the unit.

This label will indicate the vehicle’s gross vehicle weight rating (GVWR). This is the most weight the fully loaded vehicle can weigh. It will also provide the gross axle weight rating (GAWR). This is the most weight a particular axle can carry.

In the same location as the certification label described above, there is a vehicle placard. This placard provides tire and loading information.

Cargo Capacities

[For TT] Cargo can be added to the vehicle, up to the maximum weight specified on the placard. The combined weight of the cargo is provided as a single number. In any case, remember: the total weight of a fully loaded vehicle can not exceed the stated GVWR.

Water and propane also need to be considered. The weight of fully filled propane containers is considered part of the weight of the RV before it is loaded with cargo and is not considered part of the disposable cargo load. Water however, is a cargo weight and is treated as such. If there is a fresh water storage tank of 100 gallons, this tank when filled would weigh about 800 pounds. If more cargo is being transported, water can be off-loaded to keep the total amount of cargo added to the vehicle within the limits of the GVWR so as not to overload the vehicle. Understanding this flexibility will allow you, the owner, to make choices that fit your travel and camping needs.

When loading your cargo, be sure it is distributed evenly to prevent overloading front to back and side to side. Heavy items should be placed low and as close to the axle positions as reasonable. Too many items on one side may overload a tire. The best way to know the actual weight of the vehicle is to weigh it at a public scale. Talk to your RV dealer to discuss the weighing methods needed to capture the various weights related to the RV. This would include weights for the following: axles, wheels, hitch, and total weight.

How Overloading Affects Your RV and Tires

The results of overloading can have serious consequences for passenger safety. Too much weight on your vehicle's suspension system can cause spring, shock absorber, or brake failure, handling or steering problems, irregular tire wear, tire failure or other damage. An overloaded vehicle is hard to drive and hard to stop. In cases of serious overloading, brakes can fail completely, particularly on steep hills. The load a tire will carry safely is a combination of the size of tire, its load range, and corresponding inflation pressure.

Excessive loads and/or under inflation cause tire overloading and, as a result, abnormal tire flexing occurs. This situation can generate an excessive amount of heat within the tire. Excessive heat may lead to tire failure.

It is the air pressure that enables a tire to support the load, so proper inflation is critical. Since RVs can be configured and loaded in many ways, air pressures must be determined from actual loads (determined by weighing) and taken from the load and inflation tables provided by the tire manufacturer. These air pressures may differ from those found on the certification label. However, they should never exceed the tire limitation for load or air pressure. If you discover that your tires cannot support the actual weights, the load will need to be lightened.

Tire Speed Rating

Each original tire installed on KZ RV recreational vehicles have a speed rating of 75 mph or greater. Please note maximum load rating, tire pressure and speed rating as imprinted on the sidewall of tire.

Tire Safety Tips

Preventing Tire Damage

- Slow down if you have to go over a pothole or other object in the road.
- Do not run over curbs or other foreign objects in the roadway, and try not to strike the curb when parking.

Tire Safety Checklist

- Check tire pressure regularly (at least once a month), including the spare.
- Inspect tires for uneven wear patterns on the tread, cracks, foreign objects, or other signs of wear or trauma.
- Remove bits of glass and foreign objects wedged in the tread.
- Make sure your tire valves have valve caps.
- Check tire pressure before going on a long trip.
- Do not overload your vehicle. Check the Tire Information and Loading Placard or User's Manual for the maximum recommended load for vehicle.

Note: Tires are warranted by the manufacturer of their respective brand and are to be serviced and warranted by a service center.
Contact your dealer for information on service centers for tires.

How to Change a Tire

1. Place blocking under the main rail of frame with hydraulic jack on top of blocking in front of spring hanger, ALWAYS on main rail.
2. Break lug nuts loose before raising coach/ DO NOT remove nuts.
3. Raise coach with jack until tire is off the ground.
4. Place additional blocking under frame for security support. Do not depend on the jack only.
5. Be sure coach is solid and will not move with tire and wheel off.
6. Remove lug nuts when tire is off the ground.
7. Place spare tire and wheel onto hub.
8. Reinstall lug nuts and tighten firmly.
9. Drop tire and wheel onto ground after removing supports
10. Now tighten lug nuts fully at 90 to 100 foot pounds
11. Place all equipment into coach or tow vehicle, blocking and jack.
12. Re-torque wheel after traveling 100 miles.

WHEEL BEARINGS

ALL wheel bearings are pre-lubricated during assembly of axle and brakes.

Your coach may have “ ULTRA LUBE” method of having a grease fitting in the end of axle. Remove rubber cap on the end of the axle and use a standard grease gun to place 6 to 8 shots of grease into the bearings, (because you failed to repack bearings) before leaving on trip. Don't forget to repack bearings as per maintenance manual when you return home.

Lugs

When the wheels are installed on your recreational vehicle, the lug nuts must be tightened at 90-120 foot pounds of torque. Powder coat painted wheels may require more torque attempts due to thickness of paint. You must re-torque the wheel lugs at 50 and 200 miles. A decal on the wheel may require torque earlier.

After your first trip, check the wheel lugs periodically for safety. The wheel lugs should then be checked after winter storage, before starting a trip or following extensive braking. The size of bolts or nuts is 13/16 inch standard and 3/4 inch for chrome nut. **Over torque will damage components especially if torque wheel lugs goes over 150 pounds. Normally the “nut” fails first however the embossing on the wheel can also be flattened, and then fail to keep the wheel tight.**

Brakes—Electrical

Electric brakes on your recreational vehicle are designed to work in conjunction with the hydraulic brakes on your tow vehicle. This means to have the best brake performance on both systems, the trailer and the tow vehicle must perform and operate together. Any attempt to use either the brake system alone, tow vehicle or trailer will cause accelerated wear and damage.

A brake control is required to operate brake system, which is mounted under the dash of your tow vehicle, using 12 volt D.C. power. Electronic type is used most widely. Each brand has their own operating instructions.

Battery in the tow vehicle is the primary source of power to operate the brake system in towable trailer. Keep battery and charging system in good working condition to ensure available energy when

required.

Wiring to operate your brakes must be sized in both vehicles, suggesting a minimum of 14 gauge. Your camper has 14 gauge from front end to brakes. Brake assemblies are wired in parallel, never in a series. Being parallel, there will be equal voltage and amperage at each brake assembly for equal braking capability and/or performance.

Use the foot pedal to for general operation on combined use of both brake systems. Manual control is to be used only in special situations, such as slow movement or icy road conditions. In open road position, electrical current will flow to brake assemblies activating them along with tow vehicle.

Power from the battery is sent to the controller, the “switch” to provide the correct amount of circuit to the brake assemblies on the coach. As you press harder on the brake pedal, more current will flow, applying brakes more, increasing stopping capability.

When applying brakes to stop the trailer, begin pressing slowly to avoid quick and sudden stops, or possible “jack-knife” when wet or slippery conditions exist. Use lower gear ranges to minimize the need of brakes during extended or steep down grades.

Your coach has self-adjusting brake assemblies that will correct any looseness in operation as they will adjust in forward or backward movement as soon as towing begins.

Breakaway Switch

The breakaway switch is a safety part of your trailer’s electric brake system. The very instant a breakaway occurs, the pull pin which is linked to the tow vehicle is pulled from the switch. The two contacts automatically close to complete the electrical circuit and apply the trailer brakes. This system will apply the brakes of the trailer should it become loose or detached from the tow vehicle. A 12-volt battery installed on the coach is required to power the breakaway switch.

Never use this breakaway switch and trailer brake system as a parking brake. There would be a high amp draw on battery and convertor, potentially causing damaged wiring, connectors, and breakaway switch plus unnecessary energy draw. When plunger is pulled there is a constant 12 volt draw energy source to the brake assemblies.

CAUTION; Removing plunger with power to brakes could result in damage to brakes.

WARNING; Removing plunger while in storage could result in corrosion of unit points.

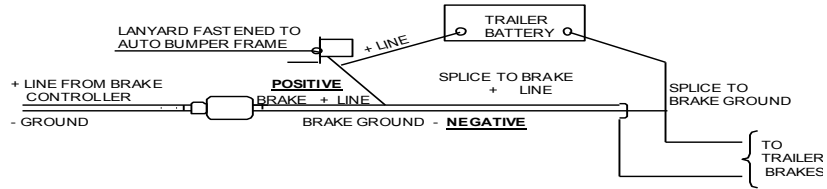

**SAFETY BREAK-AWAY SWITCH
WILL NOT OPERATE**
Unless connected to a power source
equivalent to or greater than an auto-
motive type 12 volt, 12 amp hour
wet-cell battery.

FIRE EXTINGUISHER

A fire extinguisher is installed in each vehicle and is located near the entrance door in the recreational vehicle. Be familiar with its location and operating instructions as printed on the extinguisher. Inspect your fire extinguisher at least two times per year or more often, as instructed on the extinguisher.

SETTING UP AND USING YOUR RECREATIONAL VEHICLE

We recommend that you select a level or nearly level place for camping. There are two reasons to be level. First, all components in your coach, such as your water drainage system and especially your refrigerator, are designed to operate in a level position. Second, it is more comfortable to live on the level. Should a level site not be available, use short 2 x 6 inch blocks of wood to raise the low side wheels to a level position.

Before unhooking the trailer from the tow vehicle, be sure the jack foot is in place on the tongue jack and block the trailer wheels to keep the trailer from moving.

Before lowering the tongue jack, you may wish to place a wood

block or hard support under the foot of the jack, unless you are on a cement slab. This helps to prevent the jack from sinking into the dirt.

Travel Trailer Hook Up

1. Release the weight distributing bars (if used).
2. Release the safety latch on the coupler.
3. Raise the coupler on the A-frame by turning the tongue jack until the ball is free.
4. Disconnect the 7-way wire connector, safety chains, and the breakaway cable.
5. Raise front jacks until tow vehicle will clear coach. Drive tow vehicle away.
6. Now raise/lower front end until coach is level.
7. Lower stabilizer jacks to desired position to stabilize coach.
8. Reverse procedure to hook up coach to tow vehicle.

The use of stabilizer jacks on a recreational vehicle is a popular and useful option. They provide a reasonable amount of stability while using, occupying, and moving around in your camper. It is important to remember that stabilizer jacks are for support of the coach and are not designed to bear the weight of a recreational vehicle.

To operate the stabilizer jack, place crank onto the jack shaft and turn clockwise to lower until the frame begins to raise slightly. Equalize all four jacks for best support. You may need to adjust each jack two or three times.

To raise jack to upper travel position, insert crank and turn counterclockwise until jack is seated in UP travel position.

Upon completing the setup of your coach, you are now ready to make attachments to various facilities:

- ❖ Waste water hose connections.
- ❖ 110-Volt power cord electrical hookup.
- ❖ Turn on propane tanks and light pilot lights, if any, on appliances. Remember there may be air in your propane lines. Be sure to bleed them before planned usage.
- ❖ Open any windows and roof vents as desired for ventilation.
- ❖ Fresh water connections.

You may have additional accessories and options, such as an awning on the door side which need to be opened. Separate instructions are provided by the manufacturer of these components.

SAFETY DETECTORS

Propane/Carbon Monoxide Detector



CAUTION

When preparing to depart or move, don't forget to reverse the preceding procedure. Remember, open windows, or roof vents left in the up position are subject to wind damage in transit.

Any recreational vehicle which contains a propane fuel system with propane consuming appliances requires a propane leak detection device for safety protection. Currently this detector also serves as a carbon monoxide protection device. A converter or auxiliary battery is required to supply 12-volt DC energy to operate the device. There is no master cut-off switch to disengage detector.

WHAT IS CARBON MONOXIDE?

Carbon Monoxide (CO) is a highly poisonous gas which is released when fuels are burnt. It is invisible, has no smell and is therefore very difficult to detect with the human senses. Under normal conditions, in a room where fuel burning appliances are well maintained and correctly ventilated, the amount of carbon monoxide released into the room by appliances is not dangerous. These fuels include: wood, coal, charcoal, oil, natural gas, gasoline, kerosene, and propane. Such gases can build up in the blood, interfering with the body's ability to supply oxygen to itself. Because CO is a colorless, odorless, tasteless, and highly poisonous gas that prevents the blood from carrying oxygen to vital organs, CO is 200 times more likely to replace oxygen in the blood. It can endanger lives even at low levels of concentration.

DUAL SENSOR TECHNOLOGY

The SAFE-T-ALERT 35 series combination CO/Propane Gas Alarm is an alarm that combines into a single, compact system a powerful alarm that detects both Carbon Monoxide (CO) and explosive gases propane (LPG) and Methane Natural Gas). The 35 series uses the latest microprocessor technology combined

with two electronic self-cleaning sensors that operate independently of each other. The combined unit can detect CO and explosive gases simultaneously.

OPERATION

When the unit is first powered up, The CO sensor requires a ten (10) minute initial warm-up period to clean the sensor element and achieve stabilization. The GREEN LED indicator will flash on and off during the 10 minute warm-up period. The unit cannot go into a CO alarm during the warm-up period. To test your unit during the warm-up period, press the test button. See Test Procedure in this manual. After the warm-up period, the GREEN power ON indicator should glow continuously. If the ON indicator does not light, see the section, **Trouble-shooting Guide**, in the user's manual for further information. **DO NOT attempt to fix it yourself.**

Gas Alarm: When you power the it has a warm-up period of approximately 1 minute. This unit cannot go into a gas alarm during the warm-up period. After 1 minute the alarm can detect explosive gas and will energize the relay on models 35-742-R and 35-742-R-MS.

Simultaneous CO and Gas Alarms—Because the risk of a propane gas explosion is generally a more serious danger, your alarm unit gives the gas alarm a higher priority during simultaneous alarm condition.

If your unit generates alarms for both Gas and CO at the same time, the gas LED will flash red and the beeper will sound. The CO LED will be a solid RED until the CO is ventilated out of the RV, at which time the LED will return to the GREEN operation/safe color.

Brownout Protection—The unit can tolerate short power interruptions and brownouts where the circuit voltage drops as low as 1 VDC. If the brownout lasts too long, the unit will reset and operate as described above.

LOW POWER OPERATION

This alarm will operate normally down to 7 VDC. Do not operate this alarm below 7VDC.

VISUAL AND AUDIBLE ALARM SIGNALS

This SAFE-T-ALERT CO/Propane Gas Alarm is designed to be easy-to-operate. The alarm has two indicator lights that display a specific color for each monitored condition. There also is a matching sound pattern for alarm condition.

CO ALARM

The Red CO LED will flash and the alarm will sound 4 “BEEPS” then be silent for 5 seconds. These signals indicate that the CO level is over 70 ppm. **IMMEDIATE ACTION IS REQUIRED.** See the **Procedures To Take During An Alarm** in the user’s manual that is supplied with the detector. This cycle will continue until the TEST/Mute button on the front of the alarm is pressed. Ventilate the RV. The RED light will stay ON until the CO has cleared, or the alarm will Reactivate in approximately 6 minutes if CO is present. **DO NOT RE-ENTER THE RV.** This alarm will return to normal operation after the RV’s properly ventilated.

PROPANE GAS ALARM

The RED LED will flash and the alarm will sound a steady tone whenever a dangerous level of propane is detected. **IMMEDIATE ACTION IS REQUIRED.** See **Procedures To Take During a Gas Alarm** The detector will continue to alarm until the Test/Mute switch on the front of the alarm is pressed. Ventilate the RV. The RED LED will continue to flash until the gas has cleared, or the gas alarm will reactivate in approximately 5 minutes if the gas is still present. **DO NOT RE-ENTER THE RV.** This alarm will return to normal operation after the RV is properly ventilated.

MALFUNCTION/SERVICE SIGNAL. If any malfunction is detected, the Gas LED will remain off and the Operational/CO LED will alternate Red/Green and the alarm will sound once every 15 seconds. Press the Test/Mute button. If the Test/Mute button does not clear signals, check the battery voltage. **If the battery voltage is not low and the unit will not return to normal operation, immediately remove the alarm and return for service or warranty replacement.**

<u>OPERATION</u>	<u>AUDIBLE SIGNAL</u>	<u>VISUAL SIGNAL</u>
NORMAL	NONE	STEADY GREEN
CO ALARM	4”BEEPS” 5 SECONDS OFF	STEADY RED

PROPANE ALARM	CONSTANT	FLASHING RED
ALARM MALFUNCTION	“BEEP” EVERY 30 SECONDS	ALTERNATING RED/GREEN
END OF LIFE	“BEEP” EVERY 30 SECONDS	RED?RED GREEN/GREEN FLASHING



WARNING!

LIMITATIONS OF CO AND GAS ALARMS
THIS ALARM WILL NOT WORK WITHOUT POWER
 Some reasons for no alarm power are; a blown or missing fuse; broken wire; a faulty wire connection or circuit breaker; a discharged battery; cut lead wires, or improper supply (+) or ground (-) connections.

SMOKE ALARM

Smoke alarms are required when propane is in coach and open flame cooking happens. Alarm is placed on ceiling between bed room and kitchen.

Energy to operate is supplied by a 9 volt battery inside of alarm.

Operation: The smoke alarm is in operation once the battery is correctly connected. The LED will flash every minute to show the battery is supplying power to the alarm. When production of combustion is sensed, the unit sounds a loud alarm which continues until the air is cleared.

Each smoke alarm has its own manual and is normally found in your supplied materials with coach.

TESTING

Test the alarm by pushing the test button on the smoke alarm cover for at least 3 seconds, until alarm sounds. The alarm sounds if all electronic circuitry, horn and battery are working. If no alarm sounds, the unit has a defective battery or other failure and must be replaced immediately. Life of alarm is 10 years maximum.

The test button accurately tests all functions. Never use an open flame, match or lighter as you may ignite the alarm. Also do your testing at arm's length due to loud horn and damage your hearing.



WARNING

Test smoke alarm operation after vehicle has been in storage, before each trip, and at least once per week during use. Failure to comply may result in serious injury.

TV Antennas (Standard Roof Mount)

To raise the antenna turn crank clockwise in UP direction approximately 13 turns or until some resistance to turning is noted (figure 1),

On amplified models, 12 volt DC power is required for full performance. Turn the power supply ON with the push button switch (figure 2). Power moves to the head of antenna, activating the inbuilt module, returning amplified signal to both coax leads in the coach.

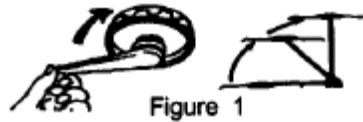
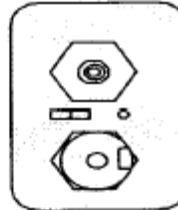

Figure 1

Figure 2

WARNING
DO NOT connect high current devices such as hair dryers to this receptacle. Maximum current rating of this receptacle is 7.5 amps at 12 VDC.



After the antenna is in full UP position, pull down on the round knob with both hands until it disengages from the ceiling plate. Rotate for best picture (figure 3).

Figure 3



To lower the antenna to traveling position, rotate the antenna until pointer on directional handle aligns with pointer on the ceiling plate. Turn the elevating crank counterclockwise in DOWN direction about 13 turns or until resistance is noted. The antenna is now locked in travel position (figure 4).



Figure 4

To test system

1. Make sure the television is working properly.
2. Switch the power supply ON and OFF to see if there is a difference in the picture quality while watching TV. If NO difference, test for 12 volt power at the cable on the roof top, as 12 volt D.C. power must be there to activate power booster in antenna head.

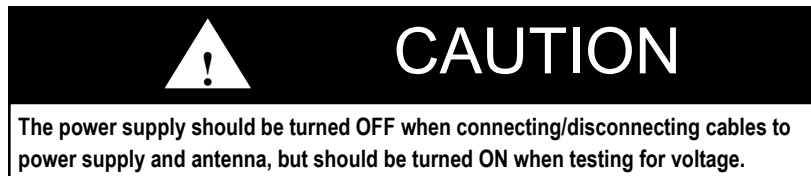
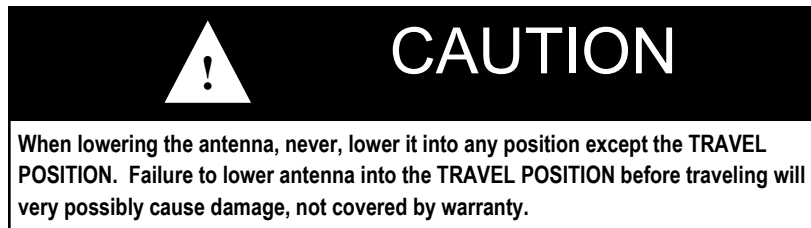

Steps (two or three)

Before entering your RV , place your hand in the center of the step assembly on bar and pull outwards. The step assembly may rise slightly and then come out, away from coach.. The lower step will unfold 180 degrees to a usable position.. Step care, maintenance and lubrication will be found in the maintenance manual.



Windows

All windows are solid picture window, or sliders panels, horizontal or vertical Egress windows have an unlocking handle or 2 small clips on each side. After unlatching, the panel will swing out on a top hinge. Screen may attached to window panel.

Doors

Locks on entrance doors have two lock mechanisms, a deadbolt and standard lock in the same assembly, both using the same key.

Screen doors have a hook/lever type of latch. Pull lever downward to release the door

Locks on trunk doors use both thumb and keyed latches. Silicone spray used on these latches will help operation.

SLIDE-OUTS

With different models of trailers, VENTURE RV uses numerous slide out systems as listed below, followed by descriptions. Several different vendors supply components, loose and/or attached to frames.

1. Below floor system - All metal components are external, located under floor and in frame, inside of enclosed underbelly cover.
2. Above floor system - All components are inside and above floor, to be found under dinette or sofa slide out.
3. In wall system— Components are mounted in the wall by the slide out sidewall opening.

Before operating the power slide-out system in your coach, read and become familiar with these instructions, along with components and operation methods. Most of these components are enclosed and can't be seen.

POWER FOR OPERATION

All power slide systems operate on 12 volt DC power provided by a fully charged auxiliary battery, which is an aftermarket item, and a converter. Thru a 12 volt distribution load center, breakers are provided for each slide. For best performance, have 120 volt AC power attached to your coach, feeding the distribution load center. Tow vehicle 12V power may also be used as required.

A automatic reset breaker is located in the distribution box feeding the operation switch to the motor.

Supplement your battery by either one of two choices:

1. Hook up a 120-volt AC power cord to recreational vehicle for

converter operation.

2. Use 12 - volt power through the tow vehicle to the recreational vehicle battery or batteries.

Either of these methods will help ensure maximum electrical power for the slide-out motor, as well as maintain your battery

TRAILER SET-UP REQUIREMENTS - GENERAL

Note:

1. Before operating the slide-out room, level the trailer front-to-rear and side to side.
2. Extend all stabilizer jacks to make solid contact with the ground and/or on solid blocks. Placing stabilizer jacks onto a hard surface allows the coach to remain square and assure a good weather tight seal between the room and trailer sidewall.

 WARNING
<ul style="list-style-type: none">◆ Always make sure that the trailer is level before operating the slide-out room.◆ Always make sure there are no obstructions blocking the path of the room when it is moving.◆ Always make sure that the room path is clear of people and objects before operating.◆ Always keep away from the slide rails under the coach when the room is in motion.
FAILURE TO FOLLOW THESE INSTRUCTIONS COULD RESULT IN SERIOUS INJURY OR DEATH.
 WARNING
Stand clear of the room's interior path and verify that the room's exterior path is clear before extending or retracting the room.
 CAUTION
When opening slide room, DO NOT over-extend. Fascia board can be distorted, loosened or bent from correct position

BELOW FLOOR SLIDE SYSTEM

Under floor slide-out mechanism steel bars are welded to the frame members. A “cog” track is welded to bottom side of cross member, matching with a gear attached to drive shaft, “LCS (Lippert Component System.) As motor turns, a actuator moves the gear on the track (ram). A cross shaft, front to rear ram connects the second ram, moving the opposite end of slide. Mechanism operates the same, flush or standard floor.

ABOVE FLOOR SLIDE-OUT

This system also operates on an inside ram assembly on a track moved by a cog gear. Ram is attached to the floor and side wall with a moving track attached to the slide-out. On larger slides, two (2) rams will be used with cross shaft connecting the 2 rams. A steel frame carriage style is used on some models, doing same function generally as a 12’ slide. Access to these components is inside of coach, under slide floor.

OPEN : Hold operation switch until room seals tightly on the exterior of the unit. DO NOT distort or bend the exterior flanges or interior fascia by holding the switch in the “ON” position.

CLOSE : To retract, reverse the procedure and hold button until the room is fully inside with gaskets sealing to the outer wall. It takes about 20 seconds to move the slide in or out.

VENTURE RV does NOT require or suggest blocking, supports, jacks, etc., to be used under slide outs during extended normal use.

Electrical Components

A 12 volt DC motor is located under the frame. It may be inside of main rail on frame, or on some models it will be on the outer side on main rail along with front to rear shaft. On the above floor slide, it will be under the floor of the sofa or dinette. The in wall slide room system motors are installed in the wall.

Operational switch: This switch, is a three position, (off center, in or out) spring loaded switch. Select which direction you wish to move the room. Press on desired position and hold until room is seated, and gasket is slightly compressed. Do not force the room to move beyond sealing as damage could occur.



MANUAL OVERRIDE:

BELOW FLOOR SLIDE OUT

Should a power failure occur (no 120 volt AC power or the battery loses its charge), follow the directions listed:

There is a 1/2" shaft coming through the main rail of frame. On the end of the shaft is a 3/4" nut attached. Use a 3/4" socket with extension and ratchet to move the slide. On some units the stabilizer jack crank handle will also work on this shaft with the attached 3/4" nut.

ABOVE FLOOR SLIDE-OUT

Manual Override (Single or Double Rams)

Should 12 volt power fail and there is no 120 volt AC power available, follow the directions listed.

Access to the ram under the floor of slide, sofa or dinette, is from the front. Lippert Component System has a smaller motor, less draw and requires a 5/8" socket, ratchet and probably an extension shaft.

BLINDS

Any blinds with loose cords, such as mini-blinds **CANNOT** be installed in bunks designed and built for young children.

Night shades installed have cords anchored to lower part of window and need to be secured for operation. VENTURE RV recommends these shades be in the UP position for travel to avoid lower metal holder being in contact with garnish on window.



WARNING

These individual tassel cords reduce the strangulation hazard in the pull cord by removing the loop.

Do not tie cords together. Check periodically to make sure the cords have not twisted into a loop

This device will not prevent strangulation hazard if young children wrap pull cords around their necks. Always keep cords out of the reach of young children.

CAUTION : While traveling, all mini blinds need to be in the “up” position to avoid swinging and scratching paneling. Even with brackets at lower part of window, pull blinds up before traveling.

LADDER— OUTSIDE

Ladder is provided as an option on most coaches to climb onto roof areas. Ladders are rated to handle up to 200 pounds at a time when climbing onto roof.

DO NOT store or transport articles on the ladder during travel. If you choose to do so, warranty will become void on the ladder.

Loose furniture, such as dinettes and free standing chairs, need to be secured to prevent movement , causing damage to walls and chairs.

CHAPTER 4 SYSTEMS

WATER AND DRAINAGE PLUMBING

Your Venture recreational vehicle has a complete water system, to carry fresh water, as well as holding tanks for used water. Each group has its own explanation along with its own operation.

FRESH WATER SYSTEM

Tanks

Water containers are installed under the coach between frame members and protected with a cover and a steel frame carrier. Each storage tank has an overflow line, 4 times smaller than a fill hose. Leaving tank being filled unattended may cause tank to be overfilled, pressurized, breaking, leaking, and bending carrier frame, which is NOT a manufacturing defect.

DO NOT install a shut off valve at the lower end of overflow line as the same situation could occur as above.



DO NOT leave tank unattended while filling, as an over filled tank will built pressure, causing tank to crack, rupture, and leak or even damaging supports holding it in place.

Filling Fresh Water System—#1

To place water in to your coach fresh water system, use one of the following methods.

- A. Gravity Water Fill See Figure 2
To place water into the fresh water tank, remove cap from fill. Insert water hose 4 to 6 inches into the 1 1/4" flex tube. Open the water supply faucet. DO NOT overfill the tank as it could burst. It is not designed to hold pressure.

Figure 2



B City Water Fill See Figure 1

Water may be received into the system through a direct hook-up referred to as "CITY WATER FILL". After attaching a supply hose to the hook-up, open the faucet from supply line. Enter coach and open all faucets to relieve air from the lines. The water heater (if so equipped) will fill first. You will experience some air pockets. Allow them to escape before closing the faucets.

Figure 1



Instructions to utilize system #1.

T=Water Storage Tank.

S=Siphon hose, used to :

(a) Winterize water system.

(b) Sanitize water system.

P=Pump, 12V, DC—To supply coach with water when city water is not available.

F=Filter—Cap to be removed to cleanout or replace.

G=Gravity water fill—To fill water tank.

C=City water fill—to fill all lines.

V1= Valve to be opened ONLY when using siphon hose.

V2= Valve to be open to draw water from supply tank. Must be closed when siphon hose is used.

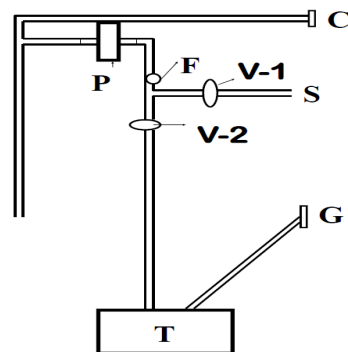

Filling Fresh Water System—#2

On some models, due to floor plan, there is no standard gravity water fill for storage tank. Inside of coach, close to pump location, on floor in a cabinet you will find 3 valves plus the siphon hose. V3 needs to be opened to fill supply tank, as shown in diagram to the right.

Follow instructions below to utilize #2 system.

F=Filter— Remove cap to clean or replace filter.

P=Pump, 12V, DC-To supply water when city water is not available.

C=City water Fill

S=Siphon hose=To draw liquid-Antifreeze or sanitize solution.

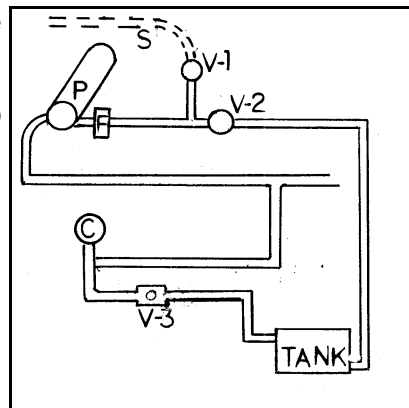

Valves to operate– Open and close to control water movement in the lines in coach.

V1= Regulates Siphon hose. Must be closed except to draw antifreeze or sanitizing solution.

V2=Valve closes line from tank to pump. Will be open during pump usage.

V3=Valve controls water to storage tank. Valve location is inside of coach, normally near water pump, on floor, under a cabinet. To fill tank, attach a hose to city water fill. Open V3 valve, then faucet to supply hose. Watch monitor panel, do not overfill your tank. Close V3 valve when done. When drawing water from tank, open V2 valve. All other valves are to be closed.

12-Volt Demand Pump

When water is desired and you are not hooked up to city water, your tank will be your supply. On your monitor panel is a switch to turn on the 12-volt demand pump. Energy for the pump is supplied by the auxiliary battery or converter. The pump will self-prime when started, supply water, and continue to run until approximately 40 pounds of pressure is achieved. When pressure drops to 20 pounds, pump will restart. Some cycling in pump may occur. A check valve is built within the pump to prevent water from flowing into the supply tank.

The pump has a small filter attached on the “in port “ side to prevent any foreign matter from entering the pump. You need to annually, or even more often, remove the lower cup and clean it out.

When pump is not in use, turn 12-volt power off at the switch.

Occasionally your water pump may start/stop quickly (within a second). This is referred to as “cycling”. The cause for this annoying noise may be a slightly open faucet, water saver washer in the end of the faucet spout, plus other restrictive issues. If pump cycles every 10 to 15 minutes, there may be a slight water leak somewhere, check valve in city water fill, plumbing fittings, or pressure valve in pump.

Faucets

The basic operation of a faucet is the same as in your home. Open the knobs for water supply. Close faucets when sufficient water volume is achieved. It is normal to experience occasional air pockets in the system.

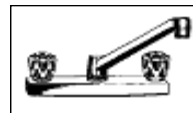



CAUTION

Excessive pressure from water supply systems may be encountered in some parks, especially in mountain regions. Water pressure regulators are available to protect your system against such high pressure. A regulator at 45 pound rating is recommended to prevent damage to the plumbing system or components.

Bath and Shower

Your bathtub and shower are built with vinyl, fiberglass, or ABS plastic material, similar to those in your home. Shower curtains are provided with the coach and must be used to prevent water from spilling onto the floor, possibly causing damage.

The shower head used in the bathroom has a non-positive shutoff valve and will drip slightly in shut-off position. A vacuum breaker is also built into the faucet to permit water in hose to drain out as a code requirement.

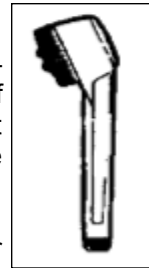

Before beginning your shower be sure the water heater is lit. Adjust the faucet for desired temperature before entering the tub or shower. When shower is completed, be sure to turn water off at the faucet.

Used water will drain through the plumbing pipes into the gray water holding tank. Remember capacities of your water heater and gray water holding tank. Long showers in a recreational vehicle are NOT suggested due to the amount of water that is available. To conserve water, wet down, and turn water off while you soap up, then rinse.

Outside Shower (Optional)

A convenient faucet assembly with hot and cold water is available for exterior use, washing or rinsing on the outside of camper, such as washing hands and utensils.

To operate the outside shower:

1. Open the door with key and allow lid to hinge down.
2. Remove the shower head and open valve.
3. Open the faucet valves and adjust to the desired temperature.

4. To end operation close valve (s) on the faucet and allow water to drain from the shower head.
5. Close the valve on the shower head.

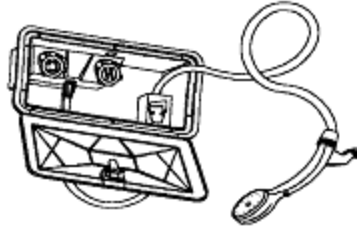

Any water remaining in the hose will drip or run out of the vacuum breaker. This is NOT a leak but performs as intended. Water in the ABS plastic box will drain out along outer edge.

The shower head can be removed to drain the hose faster. Reassemble and place onto bracket. Keep the door closed when not in use for sanitary reasons.

Fresh Water Line

Two lines, generally red for hot and blue for cold, transport water through out the coach. Valves to direct flow are near city water fill or pump area. Connector elbows and tees are plastic or copper, and are held together with compression rings for no leakage.

Low-Point Drains

Low-Point drains are placed on recreational vehicles to drain water lines, tanks, and water heater to prepare coach for winterization and sanitizing systems.

Fresh water supply tanks will have their own separate drains under the floor and/or frame, with a valve to be opened to drain, over flow drain line may be close by.

Plumbing lines also have Low-Point drains located in various areas. You may find them (2) for hot and cold coming out of storage areas, outer metal skirt, through under belly covers, control centers, etc. Water should always drain out to the ground, not into underbelly cover.

Sanitizing and Filling the Potable Water System

For your safety, you should sanitize your potable water system when your recreational vehicle is new or when it has been sitting unused for a period of time and it may have become contaminated.



WARNING

POTABLE WATER ONLY. SANITIZE, FLUSH AND DRAIN BEFORE USING. SEE INSTRUCTION MANUAL. FAILURE TO COMPLY COULD RESULT IN DEATH OR SERIOUS INJURY.

Prepare a chlorine solution using 1/4 cup of bleach (5% sodium hypochlorite solution) to one gallon of water. Prepare one gallon of this solution for each 15 gallon capacity of the tank. As designed and constructed, this method will sanitize the plumbing system.

For Gravity Fill and Storage Tank: System-#1

1. Close all the drains, tanks, lo-point drains, and have by-pass closed to water heater.
2. With the coach completely drained, open V1 valve and insert siphon hose into container with sanitation solution. Start the pump to draw liquid into the system until liquid comes through the faucets. Close faucets and pump will shut off. Lines are now full.
3. Should you desire to sanitize the tank, pour sanitation solution into the gravity water fill, which will drain into the fresh water tank.
4. Add additional water to the tank through the gravity water fill. Open faucets, close V- 1 valve, V-2 valve needs to be open. Start the pump to draw the liquid from the tank through the water system. When liquid flows freely from the faucets, close faucets. Pump will shut off.
5. Allow this water solution to stand in the system for three hours.
6. Drain solution and flush with fresh water.

For Direct Fill-City Water—System #2

1. Close all drains and have By-Pass closed to water tank.
2. Open V1 and insert siphon hose into container with sanitation solution. Turn pump on . Be sure V2 and V3 valves are closed. Faucets need to be open and then closed when liquid appears. Pump will stop when full pressure is achieved.
3. Should you wish to sanitize the tank, open V3 allowing water to flow into tank and pressure will be released. Pump will start again and run until solution is all gone.

4. Now close V1 and V2 with V3 open, add additional water to tank through the city water fill, 10 to 20 gallons. Faucets may be opened.
5. Allow this solution to remain in system for 3 hours.
6. Drain this water solution and flush with fresh water.
7. Should you have a chlorine taste, prepare a solution of 1 quart of vinegar to 5 gallons of water. Place this solution in lines as previous method. Leave in system for 24 hours.
8. Drain and flush with fresh water.
9. Your system is now ready to use.
10. Turn pump off when not being used.

When sanitizing is complete, remember to close V1 and open V2 for normal use.

The slide outs containing kitchens, will have flexible hoses installed on both fresh water lines and drain lines. Make sure there are no obstructions to allow free flow, and prevent any leakage.

Drainage (Fresh Water)

All permanent fresh water tanks can be drained. The type of drain used is a turn valve with open/close position. This drain is located under the floor underbelly.

To drain the supply lines and the entire system, you need to follow the steps listed below. Locate the valve placed at the floor level or close to the floor, found under the dinette, storage cabinet, or sofa. These valves will be at the lowest point of the water lines.

To Drain System:

1. Open all faucets including optional exterior shower.
2. Open the fresh water tank drain.
3. Open the water heater drain.
4. Open all (two to four) low-point drains.
5. Open the toilet valve, hold or block if need be.
6. To empty the pump, start and allow to run up to 20 seconds.

SANITATION SYSTEM

Toilets

The toilet used in this model, is a Thetford, Aqua Magic Residence, with foot flush.

Prior to using your toilet, be sure to add a proper amount of deodorant chemical into the toilet with water. Flush contents into tank plus two or three gallons of water.

After each flush, about two inches of water will be in bowl, which is fine for travel. For best operating function, keep four to six inches of water in the bowl. This assists flushing procedure. Always flush for ten seconds or more to ensure all solids and wastes move into tank and are not held in drainage pipes.



OPERATION: Note the photos showing movement of pedal downward. To flush, press pedal all the way down. To add water, press pedal halfway down.

When hooked up to a sewer drain at a camp ground, ALWAYS keep the termination valve CLOSED until the tank is at least 3/4 full. This will provide sufficient water to assist in complete draining of tank.

Manufacturer of toilet, Thetford Corp., offers a complete line deodorants, chemicals, and other convenience products for your use. Your dealer can assist you with these needs and may already have them in stock.

	<h2>CAUTION</h2>
<p>Keep drain valve closed. Sewer gases may be present when RV is connected to campground sewage hookup. If drain valve is open, sewer gases may be vented out the side of the RV.</p>	

Using Toilet and Tank System

When camping you should always have 4 to 6 inches of water in the toilet bowl. The toilet system performs better when you run water 10 to 20 seconds after flushing to ensure wastes will proceed to the bottom of the tank. Unlike your toilet at home which uses four to seven gallons per flush, the average recreational vehicle system uses two to three quarts. If there is not sufficient water used during flushing, waste materials may not evacuate properly from drain line to tank. Tank and pipes could eventually become clogged.

Vents

A very important part of your sanitation system is the vent system in your coach. These vents release air from holding tanks allowing water to enter. Vent pipes are attached to the holding tank, go through the walls and cabinets to the roof. On some models a portion of vent pipe may be part of the drainage system referred to as a "wet vent". As air flows upward, water will be draining downward

Holding Tanks

The final parts of your sanitation system are the holding tanks for waste materials and water. These are located below the floor of your coach.

Gray Tank. Waste water from the bath tub, shower and sinks will drain into this container. No special preparation is required, however, you may wish to add baking soda or a Thetford chemical to reduce odors from food particles in the system.

Waste Tank. The toilet drains into the waste or "black" holding tank. For correct preparation follow the listed steps:

1. Release two quarts of water into the toilet bowl.
2. Place the recommended quantity of chemicals for waste holding tank as per instructions on the bottle into the toilet bowl.
3. Flush liquids into the tank and allow up to two gallons of water to flow into the tank.

Each time you drain the tank, you should follow the instructions listed, before using.

All drain pipes will have a "P-trap" installed into each line. Water in these traps prevent odors from escaping into the coach. During travel, water from the P-traps may spill and permit odors into the coach. These odors come from fats and food particles decomposing in the tank. By adding water and using a RV approved deodorizing agent, contents will dissolve faster, keeping the drain lines and tanks clean and free flowing. These chemicals are available at a RV supply store.

Draining the Tanks

A final part of your sanitation system is the drainage of holding tanks. Realizing dump stations will vary, place the coach as level as possible to make drainage easier. Some tanks drain from the center requiring unit to be level or slightly up in front. Others will drain from end permitting a slight tilting to the side which drains are on.

Remove the cap and attach the adapter onto the valve housing. Turn the adapter 10° to lock onto the pegs. Attach a flexible sewer hose to the adapter and secure with a clamp. Place the other end into the approved sewer system.

You may now open the 3 inch drain valve to drain the sewage tank first. Open the valve on the gray water tank last to utilize water to wash and rinse the hose and drain lines.

Most states and parks have strict laws and regulations to prohibit dumping of wastes of any kind into anything other than proper disposal facilities or sewer systems. Almost all privately owned parks have either a central pump facility or offer a campsite hookup for sewage. You can find lists of many dump facilities throughout the United States in *Woodall's*, *Rand McNally Camp Guide*, *Good Sam Camp Guide*, *KOA Campgrounds Camp Guide*, or various other publications. Some fuel stations also have dump stations.

BLACK TANK FLUSH SYSTEM—OPTIONAL

The flush system is designed and built to rinse the waste holding tank, AFTER waste tank has been drained completely of water and solids.

1. Attach a fresh water source to the connection marked "Sewer Tank Flusher". Be sure termination valves are open on tanks.
2. Open valve to release water into tank for rinsing and cleaning of your waste water holding tank.
3. Rinse for several minutes to remove any foreign matter from tank, and probes.

Remember the moisture content may give you a false reading on your monitor panel indicating it is full. Allow time to dry out tank or recharge for next usage.

Maintenance for Holding Tanks

The following maintenance is recommended by our holding tank suppliers to keep your tanks clean and keep the probes free of debris and build-up.

Gray (Waste-Water) Tank. Fill tank with 8-10 gallons of warm water. Add a degreaser such as a citrus cleaner or Dawn dish soap. Leave solution in tank while you are traveling. Rinse and drain tank.

Black (Sewer) Tank. Fill tank with 8-10 gallons of water. Add one bottle of drain cleaner, such as Drano or Liquid Plumber. Leave the solution in tank while traveling. Rinse and drain tank.

Heated Fresh Water Tank

Hole or holes are placed from the fresh water tank compartment, into the floor built heat duct. This allows warm airflow into the tank area. NOTE: The holding tanks are not heated.

	WARNING
DO NOT use Ethylene Glycol (automotive antifreeze) or Methanol (windshield washer antifreeze) in your fresh water system because they are harmful and may be fatal if swallowed!	

Winterizing Your Recreational Vehicle

Preparing your trailer for cold weather is very important for most states and Canada. Failure to prepare your coach for cold weather will cause the water systems to freeze resulting in breakage. Damages related to freezing are not covered under the terms of your limited warranty.

Two methods of winterizing your coach after draining and flushing your drainage system are listed below.

Method 1:

1. Open all faucets, low point drains, toilet valve and water heater to drain all water. Leave these open during this procedure.
2. Start pump and operate until all water has been removed, takes about 10 to 15 seconds.
3. After water has been drained, use an air hose from compressor and an adapter attached to city water fill. In about 3 to 5 minutes all water will be blown out of system.
4. Pour one (1) pint (16 oz) of non-toxic RV anti-freeze into each P-Trap. Each sink has a P-Trap, as does the bathtub.

Method 2:

The water heater bypass kit is designed and built to avoid having antifreeze in the water heater.

1. Be sure to turn off the pump.
2. Drain the water heater and the entire water system.
3. Close the valve on the bottom of the by pass kit to prevent liquid from entering the water heater.
4. Place siphon hose into container with anti-freeze.
5. Open the valve on the siphon hose, which is valve V-1 from the diagram on page 51. Valve V-2 needs to be closed and V3 on the #2 water system.
6. Turn on the pump to supply the fresh water system with anti-freeze. It will take 2 gallons or more, depending on the size of the coach.
7. Allow lines to be filled and 1 pint to drain the drainage traps. Close the faucets.
8. Shut off the pump. You may wish to re-open the faucets to remove pressure from the lines.

If you do not have a pre-built siphon hose in your coach, you could purchase or build a kit to attach to the "in" port of the water pump. A winter by-pass kit is standard on all coaches.

Valve in horizontal position allows water to flow into and through water heater. Valve is on bottom portion of by-pass and choice directional flow, not a shut off.

BY-PASS KIT

When valve is in vertical position it will prevent water from flowing through water heater. A check valve is between water heater and upper tee, preventing water to flow into heater, in the upper export connection. Now you can send anti-freeze liquid through coach plumbing system without filling water heater.

Using the Water System During Freezing Weather. Your towable RV was not intended to be used during freezing weather unless special precautions are taken. Water freezes at 32° Fahrenheit in campgrounds or at home.

There is no product that can be added to the water to ensure freeze protection when the system is in use, other than RV anti-freeze. DO NOT drink water which contains anti-freeze.

PROPANE FUEL SYSTEM

The fuel system in your recreational vehicle has numerous components such as, piping, copper tubing, brass connectors, hoses, regulators and appliances. Each of these components will be explained in its appropriate area.

Propane is the only fuel permitted to be used in a recreational vehicle and its appliances. This product is refined from crude oil through natural gasses. An agent has been added for detection should a leak occur or a valve accidentally be left open. It is important for a recreational vehicle owner to recognize and identify the smell of propane vapor.

Other fuels are available but cannot be used in a RV because:

1. No orifices for appliances are available for either butane or natural gas fuels.
2. Butane also cannot be used below freezing temperature because boiling point is 30 degrees F.

Propane fuel is stored in liquid form under high pressure in special containers. Boiling point is (MINUS) — 44°F, the temperature when vapor ceases to flow. Fuel will change to vapor when released from the container. Appliances are not designed to operate with liquid. Liquid will damage o-rings in valves and also leave sticky, oily residue causing poor or no operation in the regulator.

For every 10 degree increase in temperature, the pressure in container rise's 1.5%. Example— fill at 0 degrees in north, go south 80 degrees warmer , you now have container filled at 92%, a potential problem with 10% spewing out propane vapor.

Propane Container

The propane cylinder is a D.O.T. approved container to hold liquid propane under high pressure, normally a 20 or 30 pound capacity.

The open/closing valve is to be closed at all times unless filling container or hooked up to a propane system. Top knob valve opens entry into tank. Side valve requires a POL type fitting to open the secondary valve to draw out propane vapor into system.

OPD Cylinder Valve

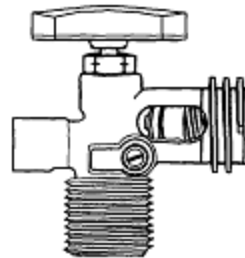

Another small knob in the main valve, referred to as 10% valve must be open when filling to release air. When vapor/liquid appears and float on inside reaches the 80% mark, container is full to the 80% mark.

At any point a container is disconnected, BE SURE to install the “dust cap” over the acme valve (if so equipped)

Whenever the container is detached from the propane system, DO NOT allow the cylinder to move or roll around during transportation to and from the gas supplier.

A high pressure hose with an ACME fitting with POL fitting must be completely and tightly installed before propane vapor can be withdrawn.

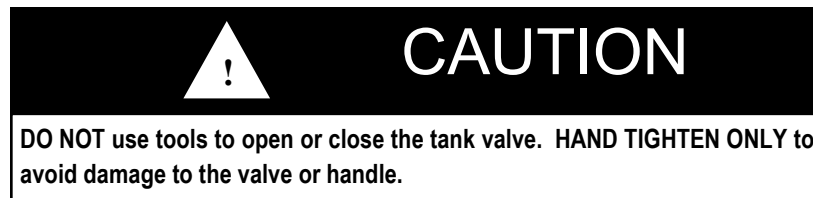

Servicing and Filling Propane Containers

Filling a propane container must be done carefully and correctly. Only a qualified person, properly trained on inspection, filling, and safety procedures, should fill containers.

To remove the propane containers for refilling.

1. Remove the bottle covers (if used).
2. Close the main valve on the container.
3. Remove the two hoses at the ACME connection.
4. Install the rubber cap over the valve - ACME connection.
5. Remove/loosen the wing nut holding the clamp hook.
6. Remove the clamp hook.
7. Fill the bottle and reverse the procedure to install. Test all connections for leakage.

A new container must be “purged” before placing into service and must NEVER BE OVERFILLED. Purging is an operation performed by your dealer or propane agency to remove any atmospheric air. As an owner you need not be concerned regarding this procedure unless you permit the valve to be in OPEN position when empty.

When refilling propane containers, they are generally removed from propane compartment or tie downs. BE SURE (a) to reinstall correctly, as you removed these components (b) and test for leaks.

When propane containers are filled to 80% level there is available space for safe expansion of the vaporized liquid. Should your container become slightly overfilled, pressure may rise due to hot sun.

When disconnecting propane containers, you must turn the acme fitting in a clockwise direction because left-hand threads are utilized. When reconnecting, turn connections counterclockwise. Connections must be tight, however DO NOT over-tighten.



WARNING

A warning label has been located near the propane container. This label reads as follows:

DO NOT FILL CONTAINER(S) TO MORE THAN 80 PERCENT OF CAPACITY.

1. **Overfilling the propane container can result in uncontrolled gas flow, which can cause fire or explosion.**
2. **A properly filled container will contain approximately 80 percent of its volume as propane.**



Installing Propane Containers

Venture recreational vehicles are equipped with 20 or 30 pound propane containers, depending on floor plan models.

Mounting and attaching instructions are listed below:

1. Thread the long rod into the base plate.
2. Set both bottles into place as shown.
3. Drop the double hook bracket over the rod and hook onto the bottle.
4. Attach the wing-nut to hold the bracket and tighten to hold the bottle to the plate.
5. Attach the regulator with the vent down to the bracket.
6. Attach the main hose from the regulator to the manifold fitting in the frame.
7. Attach two short pigtail hoses to the regulator and bottles at the ACME fitting.
8. Test all propane connections for leakage.

A warning label has been located near the propane container. This label read as follows:

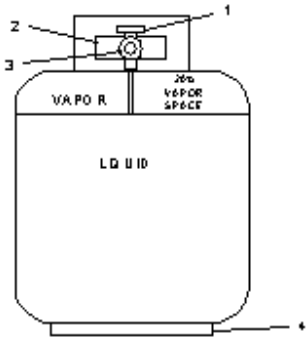
 CAUTION	
<p>THIS GAS PIPING SYSTEM IS DESIGNED FOR USE WITH PROPANE ONLY. DO NOT CONNECT NATURAL GAS TO THIS SYSTEM.</p> <p>Securely cap inlet when not connected for use. After turning on gas, except after normal cylinder replacement, test gas piping and connections to appliances for leakage with soapy water or bubble solution. Do not use products that contain ammonia or chlorine.</p>	
 WARNING	
<p>Propane cylinders shall not be placed or stored inside the vehicle. Propane cylinders are equipped with safety devices that relieve excessive pressure by discharging gas to the atmosphere.</p> <p>FAILURE TO COMPLY COULD RESULT IN DEATH OR SERIOUS INJURY.</p>	
 WARNING	
<p>Never smoke during the filling of propane tanks. Keep the recreational vehicle away from immediate filling area when possible or extinguish all gas pilots.</p>	
<ol style="list-style-type: none">1. Knob to open and close main valve.2. Complete valve assembly.3. "10% valve", (small brass knob or slot screw).4. Container mounting stand.	

ALL GAS LINES HAVE BEEN CHECKED WITH AIR PRESSURE. DEALERS ARE REQUIRED TO RECHECK BEFORE DELIVERY TO RETAIL CUSTOMERS.



DANGER

All pilot lights, appliances and their igniters (see operating instructions) shall be turn OFF before refueling of motor fuel tanks and/or propane containers. FAILURE TO COMPLY COULD RESULT IN DEATH OR SERIOUS INJURY.

Regulator

Propane regulators must always be installed with the regulator vent facing downward. Regulators that are not in compartments have been equipped with a protective cover and that cover is kept in place to minimize vent blockage. Should vent be covered or blocked the regulator CANNOT function or operate.

The regulator has the only moving components in the propane system. It's sole function is to reduce the high and varied pressure from the propane containers to safe and consistent low operating pressure. The small inlet is the first stage, which reduces the container pressure to 10-13 pounds.

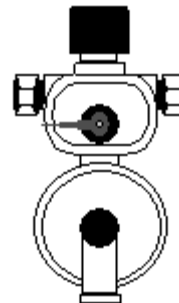
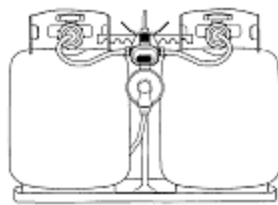

The second stage then reduces the 10-13 pound pressure to an operating pressure of 11 inches w.c. (water column) or 6.35 ounces of outlet pressure to your appliances. The second stage is adjustable and may need to be adjusted for precise operation. It is suggested this to be normal maintenance and performed once per year. Do not make this adjustment without a manometer. This instrument is required to read actual pressure.

If pressure is too high, it affects performance and safety. Should pressure be too low, appliances will not operate correctly. An authorized and competent technician with proper equipment should perform such tests and adjustments, as may be required.

The propane regulator used on the Venture units, is the automatic two stage regulator. With both cylinders full of propane, turn the lever on the regulator towards the cylinder you wish to use first. This will now be the "supply" cylinder and the other "reserve". Slowly open both cylinder valves.

The "Supply" side of the regulator will continue to supply propane as long as sufficient propane remains in the "Supply" cylinder. When pressure in the cylinder drops to about 10 psig, the "reserve" side of the regulator will open and continue to regulate at 11" WC. At the time the "supply" cylinder becomes exhausted, a red warning flag appears in the indicator window. This red flag indicates that a cylinder exchange can be made.

Before removing the empty cylinder, close the valve to prevent air from entering to cylinder.

After filling the cylinder, connect the pigtail hose and slowly open the bottle valve. Do not forget to check for leakage each time you refill cylinder or disconnect any part on the propane system.

High Pressure Hoses with Acme Connectors

Propane leaves the container through a hose with an acme connector attached to the bottle, also having a "flow-limiting device". Should the container valve be opened too quickly this device may close, stopping the flow of propane. This device is designed to equalize propane pressures in about 5 seconds, generally being unnoticed. All pilot light valves must be turned off for equalization of pressure to occur.

Main Supply Hose – Low Pressure

The main supply hose will be attached from the regulator to the brass manifold fitting in the frame of the coach. The swivel brass nut on the main hose will be your final attachment.

There are several things to remember each time the container is removed:

1. Be sure ALL fittings are tight. Always use two wrenches for brass connections.
2. Be sure ALL connections are tested for leakage.
3. Open the main valve slowly to avoid a fast rush of propane to flow-limiting device causing propane “freeze”.
4. Listen carefully – a “hissing” sound longer than one second may indicate a propane leak. Close valve and search for leak.



Should you experience a propane “freeze-up”, close the main valve and wait 15 minutes before trying again. Keep the container valve (s) closed when traveling. Some states prohibit traveling with the propane container valves open, especially in underground tunnels on expressways.

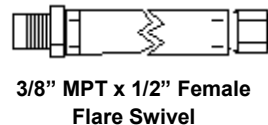

3/8" MPT x 1/2" Female
Flare Swivel

Operation

After the camper is completely set up and you are prepared for camping enjoyment, follow these steps for propane operation.

1. Be sure ALL burner valves, controls, and pilot light valves are closed.
2. Open main valve on propane container slowly to avoid a fast rush through excess flow valve causing “propane freeze”.
3. Listen carefully as propane begins to flow. If a “hissing” sound is heard for more than one or two seconds, close valve and search for a potential leak.
4. Light appliances as needed and directed in Chapter Five - Appliances.

Checking for Leaks

The entire propane distribution system and appliances have gone through complete factory and dealer tests for any leakage. When traveling with your RV, normal vibrations and road movement may cause connections to loosen and develop leaks.

For normal maintenance we advise all owners to test for leakage at least once per year or more often. You may request your dealer to perform a maintenance check each spring.

Should you encounter an odor, possibly propane, turn off any and all open flames and begin a systematic search for leaks on the complete propane system. NEVER USE A MATCH. Use a soapy water solution which contains NO AMMONIA, or CHLORINE content to check for leaks. If a leak is identified, bubbles will appear. ALWAYS use two open end wrenches when tightening brass connections to prevent twisting of copper.



WARNING

IT IS NOT SAFE TO USE COOKING APPLIANCES FOR COMFORT HEATING.
Cooking appliances need fresh air for safe operation.

Before operation:

1. Open overhead vent or turn on exhaust fan.
2. Open window (s).

FAILURE TO COMPLY COULD RESULT IN DEATH OR SERIOUS INJURY.

Unlike homes, the amount of oxygen supply is limited due to the size of the recreational vehicle, and proper ventilation when using the cooking appliances avoids danger of asphyxiation. It is especially important that cooking appliances not be used for comfort heating, as the danger of asphyxiation is greater when the appliance is used for long periods of time.



FAILURE TO COMPLY COULD RESULT IN DEATH OR SERIOUS INJURY.

For your own protection, the preceding warning label has been placed near the cooking area to remind you of the need of oxygen for combustion and breathing.. Due to smaller area in your RV, there is less oxygen than in your home. Proper ventilation is required when cooking.

It is especially important that cooking appliances **not be used for comfort heating**, as the danger of asphyxiation and unsafe levels of carbon monoxide are greater when the appliance is used for long periods of time.

Propane Consumption

All your propane appliances are operated intermittently. Your furnace is naturally the appliance using the most fuel, especially if freezing conditions are present outside. On a very cold and windy day it is conceivable that your coach could consume most of a 30 pound propane bottle.

	DANGER
If You Smell Propane:	
<ol style="list-style-type: none">1. Extinguish any open flames, pilot lights, and all smoking materials.2. Do not touch electrical switches.3. Shut off the propane supply at the tank valve(s) or propane supply connection.4. Open doors and other ventilating openings.5. Leave area until the odor clears.6. Have the propane system checked and leakage source corrected before using again.	
FAILURE TO COMPLY COULD RESULT IN EXPLOSION RESULTING IN DEATH OR SERIOUS INJURY.	
	WARNING
Portable fuel-burning equipment, including wood and charcoal grills and stoves, shall not be used inside the recreational vehicle. The use of this equipment inside the recreational vehicle may cause fire or asphyxiation.	

Propane consumption depends mostly upon individual use of appliances and the length of time operated. Each gallon of propane produces about 91,500 BTUs of heat energy. Following is a list of typical appliance consumption when turned on fully for one hour of operation.

APPLIANCE	LP GAS CONSUMPTION
Water Heater	12,000 BTU
Furnace	20,000-35,000 BTU
Stove/Oven	6,500-9,100 BTU
Refer	1,200-2,200 BTU
Note: The above chart represents many different models.	



CAUTION

If you have double bottles and a standard regulator on your RV, use only one bottle at a time. Otherwise the gas supply will be drawn equally from both bottles until supply has been totally exhausted. Using one bottle until it is empty, then using the second bottle will allow you to fill the empty bottle at your convenience without being totally out of propane.

ELECTRICAL SYSTEM

General Information

The electrical system in your recreational vehicle is designed for using both 120 volt AC (alternating current) and 12 volt DC (direct current) capabilities. All installations and designs are built to comply with safety requirements of ANSI standard 1192, National Electric Code and Canadian Standards Association.

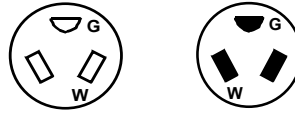

30-A, 125-V, 2-pole, 3-wire, grounding type

This model manufactured by VENTURE RV has 30 amp. service.

Highly recommend that your RV electrical connection, is not plugged into a household outlet.

Changes and Modifications

Any changes, alternations, additions, and/or modifications need to be performed by qualified electrical technicians, using only approved components which meet safety and code requirements. This includes owners, dealers, etc. who desire to make changes. The manufacturer is not responsible for any changes, or alterations, made to the 120 AC system of the coach.

120-Volt A/C System

Power Cord 30 AMP

Some units have a 30 amp rated power cord that is pre-wired into your 120-volt AC breaker box. Open the hatch door as shown, on the exterior of the coach. Pull cord out and attach it to 120-volt power source.



Other units have a power cord that is detachable from the connector as shown, to be stored inside of your unit when not in use. This cord places 120 AC volt power into your breaker distribution center, as built into your coach.

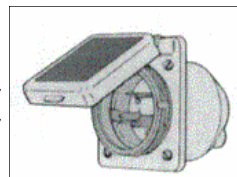

Energy will enter through the main breaker and is distributed through circuit breakers to the wall receptacles and appliances. This power cord will be approximately 26 to 28 feet in length. Each cord has the correct gauge of wire to carry the correct voltage to coach.

In some hook-ups the power cord may not be long enough and extension cords are required. Always use a cord with the gauge of wire equal to or greater than the power cord. Should you use a cord with a smaller wire gauge, overheating, loss of amperage, and possible melting could occur.

DO NOT leave any unused portion of an extension cord in a "coil" as it may overheat, short-circuit wires and potentially destroy your extension cord.

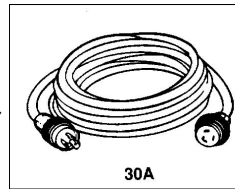

! WARNING

Never use a "cheater" plug or extension cord which breaks the continuity of the ground circuit to the grounding pin.

! WARNING

Do not replace breakers or fuses with any that are rated at a higher amperage. Over fusing may cause a fire by overheating the wire.

Circuit Breakers and Box

On a 30 amp system, a maximum of six distribution circuits are permitted. All breakers are sized according to power needs on each line. The following generic drawing shows the circuit breaker alignment with number one being the main breaker on all floor plans. Depending on the size, floor plan and options of your coach, circuit three through six will vary and possibly not all circuits will be used. Number two is generally the 20 amp air conditioner circuit.

An owner must realize and understand that a coach has a total of 30 amp service available to be used. Conserving and choosing which appliance has priority in consumption needs to be part of the planning.

Don't forget loose items such as toasters, electric skillets, and coffee pots also consume power. Include these also in your planning.

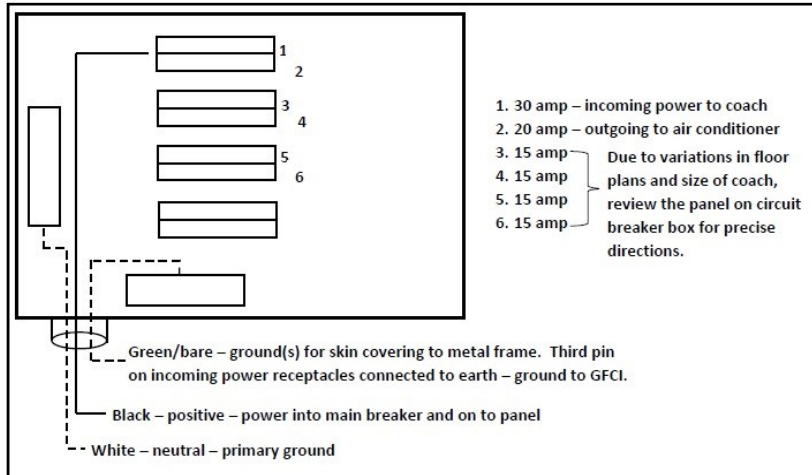

! WARNING

NEVER, under any circumstances, remove a grounding pin in any cord or plug. It may mean the difference between LIFE OR DEATH.

50 amp service (optional)—required with second air conditioner
 One ground wire/green—one neutral/ white—two positive red/green compose the 240 volt AC system. Each positive wire connects to separate power banks in distribution box. There are NO 240 VAC appliances in your coach

! CAUTION

A 50 amp service is a 240-volt hook-up. There is no appliance or other component requiring 240 volts in this coach. 50 Amp (Optional).

GFCI Protection

Each coach has a GFCI, Ground Fault Correction Interrupter, protection receptacle installed into the circuitry. This GFCI device is designed to protect people from hazards of line to ground electric shock. The purpose is to reduce possible injury caused by electrical

shock, resulting from faulty installation, improper polarity and related to moisture and/or earth ground.

The third “round” pin on the receptacle is very important for this safety device to function correctly. NEVER cut off this pin. When using an appliance in the receptacle without this provision, use an adapter with a pigtail to be attached to the receptacle box to complete the circuit.

This GFCI receptacle will not protect against short-circuits or overloads. The circuit breaker or fuse in the electrical panel which supplies power to the circuit provides this protection.

Polarity is extremely important. You should be certain that the polarity of the external power is not reversed, in order to avoid harm to appliances and personal electrical shock. Polarity testers may be purchased in most electrical and hardware stores with the GFCI tester built in.

During use of the recreational vehicle it is suggested to test the GFCJ receptacle once per month. To test, press the “TEST” button in. The “RESET” button should pop out. Power should now be turned off at this receptacle and any receptacles down line. To restore power, push, then release the “RESET” button.

12-Volt DC System

Most interior lights and appliances receive 12-volt DC power through converter output and/or the auxiliary battery. Exterior lights and brakes also use 12-volt DC power from the tow vehicle battery and/or auxiliary battery through the seven way connector and wire attached to the tow vehicle. Following are explanations of various items.

Converter

The heart of your 12 volt DC system is enclosed inside of the load center, including 12V fuse panel, 120V breaker panel and converter.

Fuse panel may have 6-14 fuse positions, depending on output size of your converter. There are also 2-40 amp fuses in converter to protect against some one hooking an auxiliary battery up backwards.

All converters have solid state electronic components internally to produce "clean" 12V DC power.

This load center will have a brown plastic front with a small door to access fuses and breakers.

Some models have fuses and breakers in a separate distribution box when 50 amp service is installed.

The function of a free standing converter takes 120-volt AC power and transforms this energy into 12-volt DC power as used in your coach. 12-volt DC supplies power for some appliances and most interior lights. The floor plan and size of coach indicate the output size.

When the converter receives 120 AC power, it transfers power into 12-volt DC without any manual switches. The converter also charges the auxiliary battery (s) when installed on the coach and is attached to 120-volt AC power. The third function of a converter is to send 12-volt power to the fuse panel and throughout the coach.

Each converter has a "built-in" fan which operates through a load sensor control or temperature sensor. As more current is drawn, fan will speed up, run faster, or slow down, based on amp draw and/or temperature. Should the fan not run at all, the converter may overheat and will cut-out and/or stop.

Auxiliary Battery

All travel trailers and fifth wheels are pre-built to accept a battery. Batteries are not standard equipment on units nor provided.

Recommended batteries are of deep-cycle type as you need longer, slow consuming power rather than cold-cranking power. A battery is always required for a break-away switch to function.

A battery requires routine maintenance for long life. First, terminals need to be kept clean to avoid corrosion. Second, a battery used daily will consume water as long as the converter is in operation. Be sure to check the battery no less than every 30 days and keep the battery filled with distilled (rain) water. Most good deep cycle batteries are NOT maintenance free.

A converter will not overcharge a battery unless a battery has a dead cell, or the converter has a malfunction. Some type of

converters have full battery charge shut-off. Other types reduce the rate of charge as battery conditions reach 12.7 volts DC or 1.265 specific gravity at 80°F. By electronic standards, a battery is discharged at 10.5 volts. Dropping voltage lower than 10.5 volts will begin damaging plates in the battery.

The interior lights will operate from the converter and/or auxiliary battery. Some lights will have wall switches and other lights have switches in the lights themselves.

Circuit Breakers and Fuses—12 Volt DC

These two items have been installed in your coach to protect circuitry and components:

Fuses are placed into the fuse panel with the converter or into a separate panel near the converter with access inside of coach. Fuses are placed in your electrical system to protect wiring and components when overloads appear or short circuits occur. Radios, stereos and possibly other components may have “in-line” fuses attached to their own wire harness.

Circuit breakers are placed at several locations. An automatic reset breaker is placed within 18 inches of the auxiliary battery. Breaker will automatically reset upon “cool down”, normally in 60 seconds.



WARNING

DO NOT replace circuit breakers or fuses with a higher current rating than those supplied with your coach. Over-fusing can cause a fire hazard by overheating the electrical wiring.

A 30 amp automatic reset breaker is installed in the load center to operate your slide-out (s).

All wiring used in your coach meets correct amp rating correlated with fuses and breakers in respective panels as required by code.

The RV battery is placed in parallel circuitry with the battery on your tow vehicle, which is NOT SUPPLIED by manufacture. Care needs to be exercised not to drain both batteries together. There are two methods of avoiding this condition:

First, disconnect the tow vehicle when parked.

Second, a battery isolator may be installed in your tow vehicle to prevent power drain from batteries in both vehicles. This device "isolator" has two useful purposes. First, it sends current from the alternator to both batteries simultaneously. Secondly, the isolator prevents draw from the recreational vehicle through the battery of the tow vehicle, preserving power to start the engine.

Contact your dealer should you desire an isolator for your protection. Two types are available, mechanical type, or solid state which is the best and most expensive.

Connector to feed tow vehicle power to exterior lights on RV.

1. Black—8 gauge-Ground—to battery-Ground
2. Red—8 Gauge-Positive= to battery positive
3. Green-16 gauge= Running and tail lights
4. Red-16 gauge=Left turn light
5. Brown-16 gauge=Right turn light
6. Blue -16 gauge=Brakes
- 7 Yellow-16 gauge=Not used (backup lights)

Breakaway switch-See chapter 3.

Junction box is where 7 way power cord and wires from coach are connected, mounted on front cross member of frame (travel trailers) and in gooseneck of fifth wheels.

A 30 amp breaker is located within 18" of battery connection on positive wire.

Auxiliary battery is not available from manufacture, but is prepared for local purchase.

Exterior Lights and Connector, 12 Volt

Power for exterior lights, such as tail lights, turn, clearance and brake lights, is supplied by the tow vehicle.

Note the diagram (above) showing the color code and numbers from the seven way connector and how power is fed to the exterior lights. The positive red wire is attached to the battery to transfer power to the coach.

The connector between the recreational vehicle and the tow vehicle may build up corrosion due to moisture. You may need to clean these terminals occasionally to insure good electrical contact.

Porch Lights

Porch lights are placed on sidewalls, left and right side. Switches for these lights, depending on models, will be in the interior, right (door side) side wall. Occasionally, the switch will be on the light itself.

Brake Wiring

The 10 and 12 inch electric brakes operate on 12-volt power supplied from the tow vehicle, transferred through the blue-positive and white-negative in the seven way harness. There are no fuses or breakers installed in this brake wiring. More information on the brake system is found in Chapter Three - Using Your RV.

If experiencing any electrical problems, check the following items, fuses, breakers, and connections. If none of these items resolve the problem, contact your dealer for trouble shooting and needed repairs

OPTIONS-involving electrical

1. With second air conditioner, 50 amp service is required. With 50 amp it means 2- 120 volt positive wires will be attached to two banks of positive power in circuit breaker box, one to each side. Power cord will have 4 prongs on it, 2 positive, 1 neutral, and 1 ground.
2. On 30 amp system with a fire place, there will be a switch in camper in which you have to choose to use the fire place or air conditioner. Switch is called a "double pull/double throw" device, located near the fire place.



Any electrical installation that does not meet the criteria of the manufacturer's specification will VOID THE WARRANTY on the electrical system.

CHAPTER 5 APPLIANCES

VENTURE RV places brand name, quality-built equipment, as guided by current codes and standards, in all recreational vehicles. Some appliances are built and equipped to operate on propane gas ONLY. DO NOT attempt to operate on natural, butane or methane gas.

Each appliance has its own specific manual, written and published by its manufacturer. These manuals supply additional information about the appliances in your recreational vehicle.

SAFETY

Most of the appliances in this chapter will use propane fuel for operation.

IT IS VERY IMPORTANT THAT YOU AS AN OWNER AND OPERATOR, ARE FULLY AWARE WHAT PROPANE ODOR IS OR SMELLS LIKE, FOR YOUR PROTECTION.



DANGER

What to do if You Smell Propane.

This section involves all appliances which use and consume propane, may or may not have a pilot light.

1. Extinguish any open flame.
2. Evacuate all persons from the vehicle.
3. Shut off the propane supply at container.
4. DO NOT start any engine or generator.
5. DO NOT touch any switch, phone, or radio in vehicle.
6. Contact the nearest propane supplier, service technician or fire department personnel.
7. DO NOT turn off propane supply until problem or leak has been solved.

**FAILURE TO COMPLY COULD RESULT IN
SERIOUS INJURY, EXPLOSION, OR DEATH**

BEFORE OPERATING take note of any unusual odor in coach near floor or elsewhere similar to propane.

FURNACE

The furnace in your recreational vehicle requires 12-volt DC electrical current and propane gas energy for correct operation. The furnace receives 12-volt DC power from a fully charged battery and/or the converter in the coach. This power must be present before propane gas can enter through the control to the burner tube.

The combustion chamber is completely sealed to prevent any carbon monoxide from entering into the coach. Oxygen is drawn into the chamber through the upper vent and exhaust fumes expelled through the lower vent.

The basic operation of furnace is performed by thermostat mounted on interior wall of your coach.

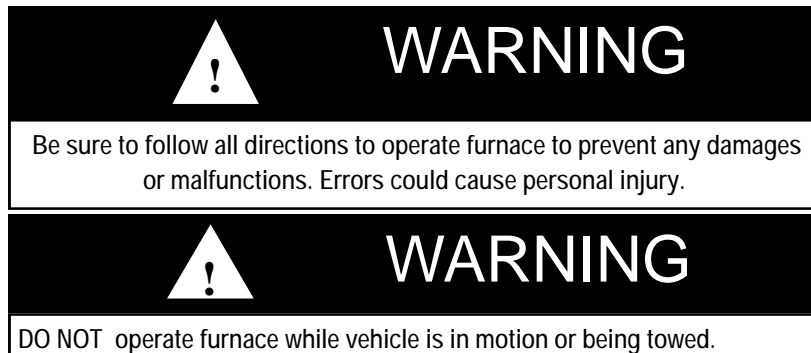

Thermostat (with air conditioner)

OFF= Means all functions will not operate until turned on.

HEAT= In this position, furnace will become active and place heat inside of coach.

COOL= Cool air will be produced from air conditioner.

FAN= Fan only will be in operation.

Slide switch in center which will set temperature as desired.

On the right side is a switch for fan operation, with 2 speeds for air conditioner., either low or high speed. Furnace has only 1 speed.

Thermostat (Without air conditioner)

Has an on/off switch and temperature setting on top.

From the time you turn the thermostat on, there is a delay built into

the furnace to perform a purge cycle preventing any possible gas vapor build-up in the chamber.

NOTE: Different model furnaces are used for different unit floor plans. Each model furnace has it's own Users Manual. The following instructions may vary slightly from the instructions in your unit. Therefore very important that you refer to the Users manual provided in your unit.

Operating Instructions

1. Before using your furnace, it is suggested to open entrance door and windows to ventilate camper for any unusual odors such as propane or other.
2. Be sure propane container has fuel and valve is open.
3. Release thermostat from OFF position and onto HEAT position.
4. Set temperature on 5 to 8 degrees above room temperature.
5. Blower will start in 0 to 15 seconds, run for 30 seconds during heat chamber PURGE cycle, removing any propane vapor.
6. Second cycle, blower continues to run, module board will: (a) send spark to the burner tube, (b) Open valve to release propane to burner tube.
7. Ignition attempt will be for 7 seconds.
8. Failing to ignite, board will make 2 more attempts to light the burner and then go to lockout.
9. If after (3) attempts with no ignition, drop thermostat to lowest setting, wait 1 minute and repeat the same steps.
10. After the burner tube lights, set thermostat at desired setting.
11. To shut burner down, move thermostat to lowest setting or to OFF.
12. Blower will continue to run for about 2 minutes until heat is removed from chamber.

To Turn Off Appliance

1. Set the thermostat to lowest setting, then move lever to " OFF " position.
2. Turn off all electric power to the appliance if service is to be preformed.
3. Turn manual valve (if so equipped) to the " OFF " position. Do not force.

External Vents. Always be sure these vents are clear of any objects like screens, duct tape, etc.

Ducting. Wall or floor registers, and return air grills MUST be kept clear of any obstructions. Any such restrictions will prevent the furnace from correct operation. Closeable registers will reduce air flow. Never shut registers off completely, possibly causing furnace to limit out and shut down.

Propane pressure, as defined in Chapter Four - Systems, is extremely important. A dial gauge or U-tube manometer is required to perform tests and adjustments. Pressure must be set at 11 inches w.c. (water column) plus or minus 1/2 inch. Incorrect gas pressure can cause any appliance to operate inconsistently and cause poor combustion. Only qualified technicians with proper equipment should make any mechanical adjustments to the regulator.

Voltage must be between 10.5 volts to 13.5 volts at the furnace during operation. Below 10.5 volts the furnace will shut down. Both high and low voltage places excessive wear on the motor and brushes.

Any mechanical adjustments, such as electrode adjustments, should be performed by a qualified service technician.

	WARNING
Do not install screens over the vents for any reason. Screens will become restrictions causing unsafe or inefficient operation.	

RANGE AND OVEN TOP BURNER OPERATION

The cooking appliance used in the Venture RV products is a standard 17" oven with three top burners. None have a 'STANDING PILOT' on top burners and must be lit , each usage with igniter by turning knob in direction of arrows , hand held lighter or matches.

OPERATING INSTRUCTIONS

Top Burners

1. Know which knob, controls which burner. Always be sure all burners are turned off when the stove is not in use.
2. Depress knob and turn fully counterclockwise to “LITE” position.
 - a. Verify sufficient propane supply before attempting to light the burner. Air in the propane line will significantly delay burner ignition. The burner may light unexpectedly as the air in the line clears and is replaced by propane. This unexpected ignition could burn you. Air in the propane lines may occur after the vehicle propane bottle and/or tank is refilled, and during and after servicing other appliances on the same propane line, etc.
 - b. Do not attempt to light more than one burner at a time.**
 - c. Immediately light the burner by turning piezo liter knob in direction of arrows . You may also use hand held liter or using matches.



WARNING

Be sure all control knobs are turned “OFF” when you are not cooking. Someone could be burned or a fire could start if a burner is accidentally left on or unattended even if only momentarily.

3. If any burner should extinguish after initial lighting or due to accidental blow out, turn propane off by turning control knob clockwise to “OFF”. Wait five minutes before attempting to relight the burner. Failure to follow these instructions could result in a fire or explosion.

If the burner should go out while cooking, or if there is an odor of propane, turn the control knob(s) clockwise to “OFF”. Wait five minutes for the propane odor to disappear. If the propane odor is still present – DO NOT relight the burners. See instructions in the appliance manual.

4. To turn the burner (s) off, turn the appropriate control knob clockwise to “OFF”.

DO NOT OPERATE THIS APPLIANCE UNLESS THE PRIVACY CURTAIN IS SECURED. FAILURE TO COMPLY COULD RESULT IN FIRE OR SERIOUS INJURY.



WARNING

When holding the match or lighter to ignite flame, DO NOT position your fingers close to the burner. You could get burned causing injury.



CAUTION

Hand held igniters may be used but be sure they are the type designed for lighting open flame burners.

Oven Burner

Note: Before the oven burner will operate, the oven pilot must be lit.

1. Lighting Oven Pilot

- a. Be sure ALL valves are in the "OFF" position. The oven control knob should be in the "Off" position.
- b. Be sure main propane supply is on.
- c. Open the oven door; smell for propane. If you smell propane, STOP! Read and follow the instructions in your appliance manual.
- d. If you do not smell propane, turn knob to the pilot position. "Push In/Lite Pilot".
- e. Immediately light pilot with a match. Hold knob in at least 5 to 7 seconds, for this allows propane to flow to pilot and to heat the thermocouple. Release knob, pilot should stay on.
NOTE: If the appliance has not been operated for a long period of time, a longer waiting period for ignition of the pilot may be due to the air in the pilot and propane lines. If pilot goes out, repeat steps a, b, c, d.

2. Operation of Oven Burner

- a. Turn the oven control knob counter-clockwise, to the desired setting. Oven burner will come on immediately and the oven burner will stay on until it reaches the desired setting. Then the oven burner flame will decrease in size. This is normal

for this type of thermostat and this flame size will maintain a constant temperature within the oven. NOTE: Oven thermostat was calibrated at the factory and is not field adjustable.

3. To shut down the oven burner turn the oven control knob clockwise to "PILOT ON" position. At this position, the oven pilot will remain lit.
4. To shut down the oven pilot light slightly depress knob and turn clockwise to " off " position. At this position, the oven pilot will go out.

WATER HEATER

DSI Models

Operating Instructions—Gas

This appliance does not have a pilot. It is equipped with an ignition device which automatically lights the burner. Do not try to light the burner by hand.

BEFORE OPERATING take note of any unusual odor in coach near floor or elsewhere similar to propane.

This has an automatic propane valve, no adjustments are necessary or possible. Do not attempt to repair the propane valve. This may result in a leaking situation.



Do not use this appliance if any part has been under water. Immediately call a qualified service technician to inspect the appliance and to replace any part of the control system and any propane control which has been under water.

Before operating the water heater, check the location of the vent to make sure it will not be blocked by the opening of any exterior door on the trailer. If it can be blocked, do not operate the water heater with the exterior door open.

OPERATING INSTRUCTIONS: DSI MODEL

1. STOP! Read the safety information provided.
2. Turn off all electric power to the appliance.

3. Turn "OFF" propane supply.
4. Wait five minutes for propane to clear the area. If you smell propane, STOP! Follow previous instructions, what to do if you smell propane. If you do not smell propane, go to the next step.

	CAUTION
When the recreational vehicle is not in use or while traveling, it is recommended that the propane supply also be turned off.	
	WARNING
Before attempting to operate any water heater, you must be sure the heater is FULL OF WATER. Failure to fill with water will result in the tank warping and the element burning up. When filling water heater with water, don't forget to open the by-pass valve to fill tank.	

5. Turn "ON" the propane supply.
6. Turn on electrical power to the appliance.
7. Turn switch marked " Gas ", which is located on bottom of the monitor panel, to " ON " position. If the burner does not light, the system will automatically attempt two more tries for ignition before lock out. NOTE: Each ignition cycle will have a fifteen second purge before spark cycle if the system is a three try system.
8. If lock-out occurs before main burner lights, turn switch to "OFF", wait five seconds and turn switch to "ON" position. This will restart the ignition cycle. The first start-up of the heater may require several ignition cycles before all air is purged from the propane lines.

	DANGER
If you do not follow these instructions exactly, a fire or explosion may result causing property damage, personal injury or loss of life.	

If the burner will not come on, the following items should be checked before calling a service person:

1. Switch turned off.

2. Propane supply to heater is empty or turned off.
3. Reset button on ECO is tripped.
4. If burner fails to light, call a Suburban Service Center or a local RV Service agency.

OPERATING INSTRUCTIONS—ELECTRIC

Electric water heaters are designed to operate with a minimum amount of service problems, however, proper operation and care is essential.

By far the most common trouble with electric water heaters results from energizing the water heater before it is filled with water. Even brief operation of the electric element without water in the tank will burn out the electric heating element.

Before the electric element will operate, the switch located behind the water heater door in the lower left corner of the control housing must be in the “ON” position.

To energize the electric element, locate the switch, which is on bottom of monitor panel, flip the switch marked “ELECTRIC” to the “ON” position. The water heater temperature will be regulated by the thermostat.



TO TURN OFF WATER HEATER:

1. Turn switch to “OFF” position.
2. Turn off the electric power to the appliance.
3. Turn off propane supply.
4. If the vehicle is to be stored or the water heater is going to be turned off while subject to freezing temperature, drain the water heater.

Winterizing Your Water Heater

If your water heater plumbing system is equipped with a bypass kit, use it to close off the water heater. Drain the water heater completely and leave the water heater closed off (out of the system) in the bypass position particularly if you are introducing antifreeze into the plumbing system.



DANGER

If the user of this appliance fails to maintain it in the condition in which it was shipped from the factory or if the appliance is not used solely for its intended purpose or if the appliance is not maintained in accordance with the instructions in this manual then the risk of a fire and/or the production of carbon monoxide exists which can cause personal injury, property damage or loss of life.



DANGER

If you do not follow these instructions exactly, a fire or explosion may result causing property damage, personal injury or loss of life.

Antifreeze can be very corrosive to the anode rod creating premature failure and leave sediment in the tank. If the plumbing system is not equipped with a bypass kit, and you intend to winterize by adding antifreeze to the system, remove the anode rod (storing it for the winter) and replace it with a 3/4 inch drain plug.



CAUTION

DO NOT operate the water heater with two energy sources in operation or without water.

REFRIGERATOR

Performance of refrigerators depends on various factors, such as, energy, venting, leveling, humidity and atmospheric heat temperatures, but not limited to these. All refrigerators are designed with absorption type of cooling units requiring careful leveling and venting conditions.

Leveling:

For correct operation, the refrigerator must be with in three degrees

of level in any direction. Operating it at more than these limits can cause damage to the cooling system and create a risk of personal injury or property damage. The closer to level, the better it performs.

Operation During Travel

While the refrigerator should be level when the vehicle is stopped, performance during travel is not usually effected.

Venting

For an absorption unit to operate fully it must have two vents. The lower vent serves as access to service components and allows air to enter. As the refrigerator heats up, warm air leaves through the upper vent in the roof or the upper side vent. The roof vent gives the best "chimney" results. However with correct baffles, side vent is efficiently. All vents must prevent birds and rodents from entering.

Moisture Reduction Heater

The refrigerator has a heater that prevents moisture from forming on the center divider between the doors of the freezer and the fresh food compartment. The heater operates only when the refrigerator is ON.

Door Sealing

Check the seal of the doors.

If either door does not seal correctly, excess frost will collect inside the refrigerator. Make sure the doors seal correctly.

- * Close each door on a piece of paper that is about the size and thickness of a dollar bill.
- * Gently pull the paper.
- * You should feel a slight drag between the gasket and the cabinet.

* Do this on all four sides.

* If you do not feel a slight drag on the paper, the door does not seal correctly.

* Have your dealer or an authorized Norcold Service Center correct the seal of the door.

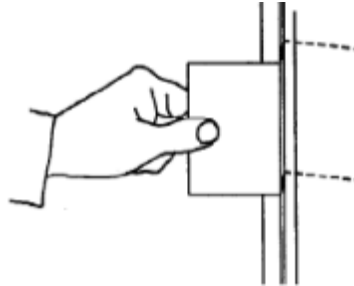

Door Handles

During travel, the door latch prevents the door from opening. When closing each door, push the door toward the refrigerator until you hear a “clicking sound”.

To open each door, pull the handle away from the refrigerator.

Refrigerator Storage

Before the refrigerator is stored for an extended (seasonal) period of time:

- Defrost and clean the interior of the refrigerator.

If the refrigerator is stored for an extended period of time, before start up:

- _ Make sure there are no obstructions in the vents, the ventilation air pathway, the burner, the orifice, or the flue area.



CAUTION

Do not use undue force or jerking action when opening the refrigerator door. Air temperature differences can cause a partial vacuum within the cabinet requiring a firm but steady force to open the door. A sudden jerk could cause door damage or personal injury.

For Defrosting and Cleaning the Refrigerator Interior, and other additional information and operating procedures, see the manual being supplied by the manufacture.

OPERATING THE REFRIGERATOR CONTROLS

Control Panel:

Control for the refrigerator is a single switch on center, front panel to turn unit ON or OFF. Should you wish to change temperature on the inside of box you must move the thermister and wire on the fins of unit.

To turn refrigerator off, just turn the switch to off.

The refrigerator control panel is between the freezer compartment and the fresh food compartment. A 12 volt DC power supply is necessary for the control functions of the refrigerator to operate. The refrigerator receives DC power from the 12 volt system of the vehicle; either an auxiliary battery, a convertor, or the vehicle engine battery.

For full operation details of all of the buttons and it's function on the control panel, refer to the Norcold refrigerator owners manual.

MONITOR PANEL

Your panel through modern technology will supply the charge condition of your battery, and water level information from your water tanks.

Operation requires 12-volt DC power, supplied by the battery or converter. Sensors, one negative and three positive, attached to a resistor feed information to the display panel. To operate, place finger on button and push. A light will illuminate indicating the water level of tanks or charge condition of battery. " Gallery " will light only when floor plan includes the second gray water holding tank.

The switch on the lower left corner is for water pump operation. When in the "ON" position, pump will run until 40 to 45 PSI is achieved. The pump will shut off and restart at 20 pounds of pressure. Turn pump switch "OFF" when pump is not in use.

The red switch in the middle at the bottom of monitor panel is for the water heater LP gas. Red switch, lower right hand corner is for Water Heater electric.

When pushing the battery button, the highest light coming on indicates the battery condition: C-charge at 12.7 volts; G-good at 11.9 volts; F-Fair at 11.2 volts; L-low at 6.0 volts. Press only one button at a time as one set of lights serves all functions.

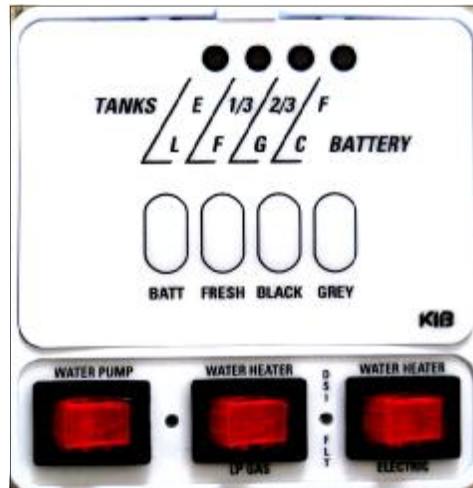

OUTSIDE KITCHEN (OPTIONAL)

Using this outside kitchen will eliminate traffic inside of your camper and perhaps avoid a food spill or dirt.

Two sizes are available, depending on model of camper and space, a short or tall version.

1. Cook top is a two burner hot plate and has no standing pilot light. Each use requires re-lighting the burner. A removable propane hose is supplied with quick-connectors for fuel from propane system.
2. A refrigerator is also a part of this package, 120 VAC, compressor type. Small unit is 1.6 cu. ft. and tall unit is 3.2 cu. ft. No propane or 12 VDC is required or available for operation.
3. Small sink and faucet is part of this kitchen. Drainage of water will go into the holding, thru a flexible hose. It also serves as an outside shower/port. A shower head and hose are included.
4. A second microwave is included with tall kitchen. You will have to choose switch microwave to use. The switch is located inside of camper, generally in the ceiling panel called a "Double pole/Double Throw" switch. There is only 30 amp service available, the reason you must make this choice.

FIRE PLACE (OPTIONAL)

Built into your camper is a fireplace, to be used for light heat duty. It produces 5000 BTU and operates on 120 VAC. A circuit breaker is located in distribution box, supplies power and protection for overload and short circuits.

A "Double Pole/Double Throw" switch is also placed in the circuitry, usually in front wall.

If problems occur with any appliance while traveling, contact the appliance manufacture direct. These phone numbers are listed in the appliance manuals. Manuals should stay in unit at all times.

Important Phone Numbers
